



ALUMINIUM PROFIEL PRODUCTCATALOGUS



BEPRO



Wie Zijn Wij?

Om te beantwoorden aan de behoeften van de sector met zijn 40 jaar ervaring en kennis in de sector, begon GNS Group of Companies met het aanbieden van professionele aluminium oplossingen door de oprichting van GNS Profil Alüminyum A.Ş. actief op het gebied van aluminium profiel in 2022. Door verder te investeren om een internationaal merk te worden, richtte onze bedrijvengroep GNS Europe B.V. op in 2023 en creëerde het "BEPRO" merk in 2024.

Onze geïntegreerde faciliteiten in de wijken Ergene en Kapaklı in Tekirdağ bieden innovatieve oplossingen op een totale oppervlakte van 35.000 m², waarvan 29.000 m² gesloten is, met geavanceerde technologische machines en een professioneel team van 150 mensen.

In onze profielfabriek maken we profielen met onze 5-7-9 inch extrusielijnen.

Onze Missie

Onze klanten de juiste combinatie van kwaliteit en prijs bieden en hen de beste service bieden als hun voorkeursleverancier van profielen.

Onze Visie

Duurzame bijdragen leveren aan de werkgelegenheid en productie van ons land in samenwerking met onze klanten. Een schone en leefbare wereld achterlaten voor toekomstige generaties door gebruik te maken van onze hoogwaardige productietechnologie. Een pionier zijn in zijn sector en een waardevol merk op de internationale markt.



Telefoon

+90 850 380 01 59

Mail

info@bepro.com.tr
info@gnsprofil.com
bepro.com.tr
gnsprofil.com

Hoofdkantoor Adres

Ataköy
7-8-9-10. Kısım Mahallesi
Nilüfer Sk, A5 Blok, No:4DB 34140
Bakırköy İstanbul



Professioneel Personeel

We leveren onze diensten professioneel met onze deskundige teams en hightech apparatuur, die over geavanceerde mogelijkheden beschikken.



Onze waarde

Erlijkheid en integriteit zijn altijd en onder alle omstandigheden onze belangrijkste waarden.

Adres Fabriek 1

GNS PROFIL
Kapaklı OSB 104. Cad. No.
No:15/1
Kapaklı / Tekirdağ

Adres Fabriek 2

GNS PROFIL
Velimeşe OSB Mah. 227 Sk.
No: 15/1
Ergene / Tekirdağ



Kwaliteit

We geven prioriteit aan de tevredenheid van onze klanten op het hoogste niveau en we streven ernaar om diensten en oplossingen te produceren die voldoen aan hun verwachtingen op een hoog kwaliteitsniveau.



Op Tijd Leveren

We komen de verplichtingen die we aangaan op een succesvolle manier na binnen de beloofde tijd.

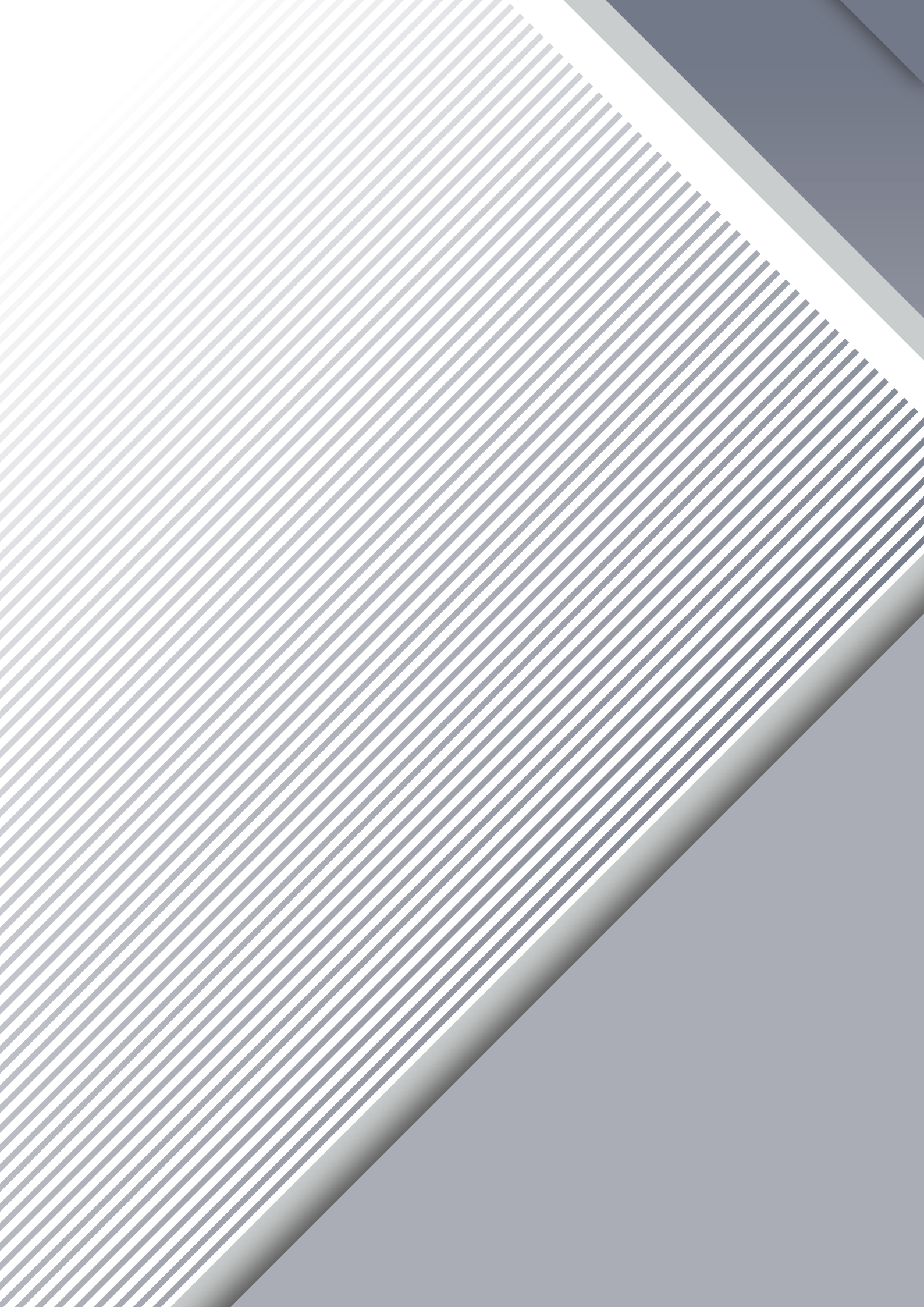

INHOUD

09

Veranda Serie Profielen

17

BQB Veranda Serie Profielen

25

Standaard Schuif Serie Profielen

33

Diamant Schuifprofielen

40

Standaard Profielen

47

Schutting Serie Profielen

55

Gemotoriseerde Bioclimatic Serie Profielen

63

Handmatige Bioclimatic Serie Profielen

69

Plafondgordijn Serie Profielen

73

C60 Serie Profielen

79

Aldoks Serie Profielen

86

Dorpel Profielen

91

Profielen Leuning Serie

99

Glazen Balkon Serie Profielen

103

Pergola Serie Profielen

107

Accordeon Deur Serie Profielen



VERANDA SERIE

 BEPRO





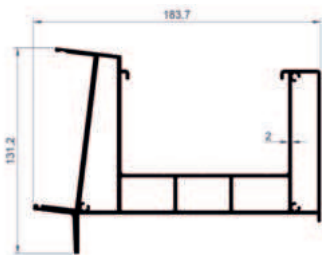

Gootprofiel

Product Code	2001
Gewicht (kg/mt)	5,274



Rech Gootprofiel

Product Code	2002
Gewicht (kg/mt)	1,249



3 Vouwgroef Profiel

Product Code	2003
Gewicht (kg/mt)	1,415



Muurprofiel

Product Code	2004
Gewicht (kg/mt)	2,201

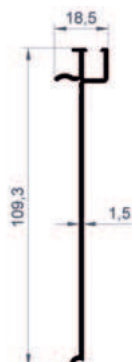

Muur En Goot Binnenprofiel

Product Code	2005
Gewicht (kg/mt)	0,580

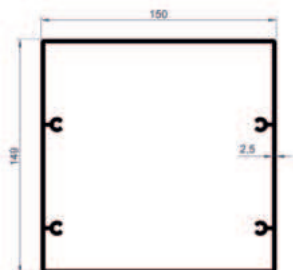

Stutprofiel

Product Code	2006
Gewicht (kg/mt)	4,482

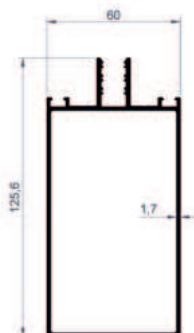

Midden Glas Dragers

Product Code	2007
Gewicht (kg/mt)	1,916

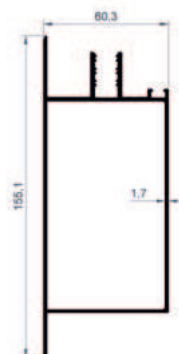

Rand Drager Profiel

Product Code	2008
Gewicht (kg/mt)	2,016

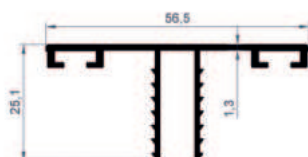

Drager Compressie Afdekprofiel

Product Code	2009
Gewicht (kg/mt)	0,436

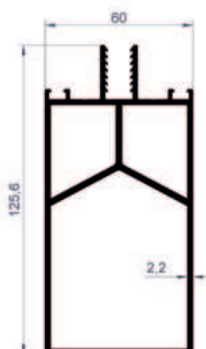

Draagprofiel Ondersteund Glas

Product Code	2010
Gewicht (kg/mt)	2,837

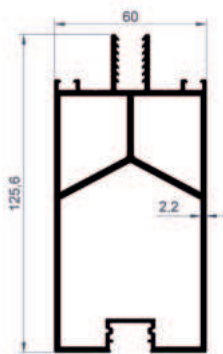

Led Geïntegreerd Glasdraagprofiel

Product Code	2011
Gewicht (kg/mt)	2,913

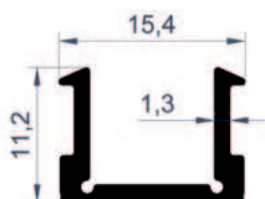

Led Geïntegreerd Glas Afdekprofiel

Product Code	2012
Gewicht (kg/mt)	0,144

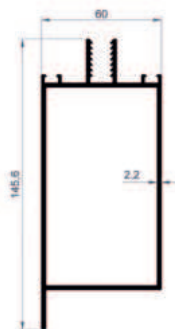

Randsteunprofiel

Product Code	2013
Gewicht (kg/mt)	2,369

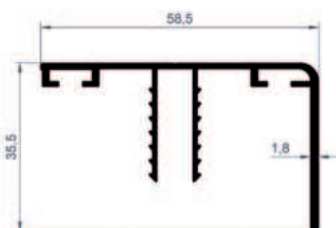

Zijwaartse Drukafdekking Voor Drager

Product Code	2014
Gewicht (kg/mt)	0,591

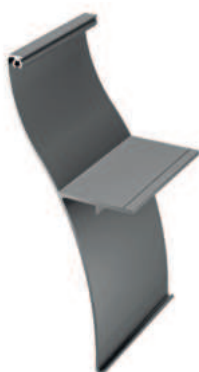

Half Ovaal Goot Profiel

Product Code	2015
Gewicht (kg/mt)	1,542

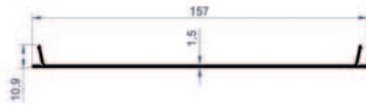
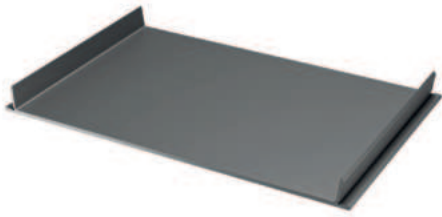

Middensteun Afdekprofiel Profiel

Product Code	2048
Gewicht (kg/mt)	0,696

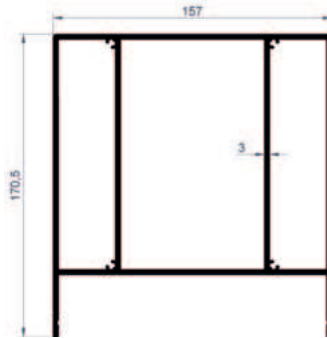

Middensteunprofiel

Product Code	2049
Gewicht (kg/mt)	7,420



Veranda Serie Profielen			
Afbeelding.	Profielnr.	Profiel Beschrijving	Kg / mt
	2001	Gootprofiel	5,274
	2002	Recht Gootprofiel	1,249
	2003	3 Vouwgroef Profiel	1,415
	2004	Muurprofiel	2,201
	2005	Muur En Goot Binnenprofiel	0,580
	2006	Stutprofiel	4,482
	2007	Midden Glas Dragere	1,916
	2008	Rand Drager Profiel	2,016
	2009	Drager Compressie Afdekprofiel	0,436
	2010	Draagprofiel Ondersteund Glas	2,837
	2011	Led Geïntegreerd Glasdraagprofiel	2,913
	2012	Led Geïntegreerd Glas Afdekprofiel	0,144
	2013	Randsteunprofiel	2,369
	2014	Zijwaartse Drukafdekking Voor Drager	0,591
	2015	Half Ovaal Goot Profiel	1,542
	2048	Middensteun Afdekprofiel Profiel	0,696
	2049	Middensteunprofiel	7,420

BQB VERANDA SERIE







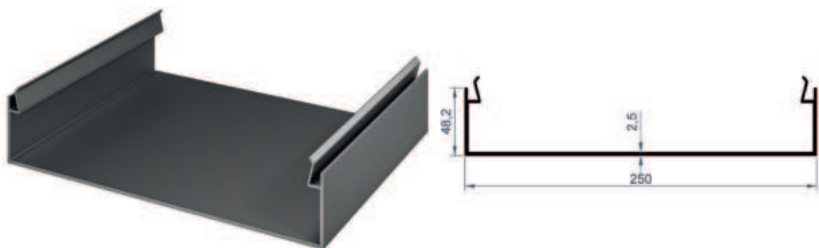

Stut Afdekprofiel

Product Code	2020
Gewicht (kg/mt)	2,528

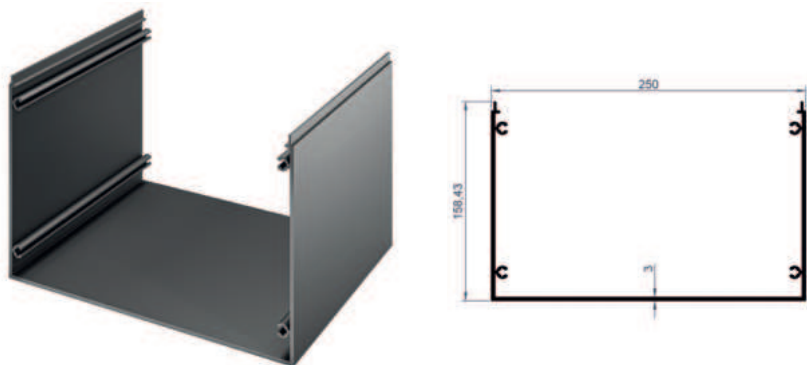

Stutprofiel

Product Code	2021
Gewicht (kg/mt)	5,030



Gootvoegprofiel

Product Code	2022
Gewicht (kg/mt)	2,913

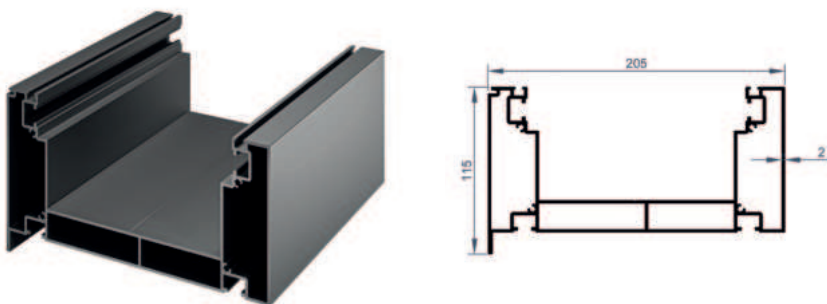

Gootprofiel

Product Code	2023
Gewicht (kg/mt)	5,168

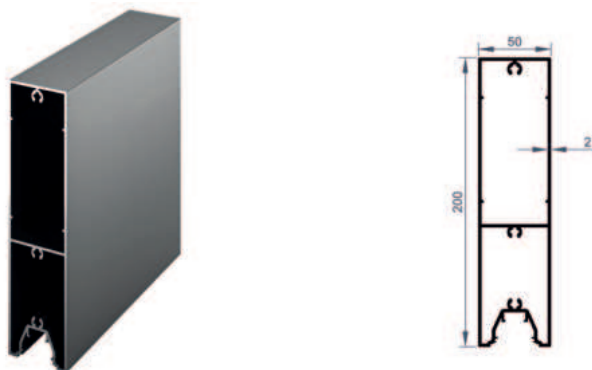

Glazen Dragerprofiel

Product Code	2024
Gewicht (kg/mt)	3,501

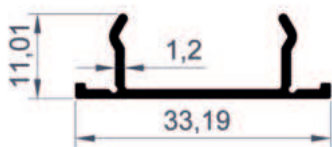
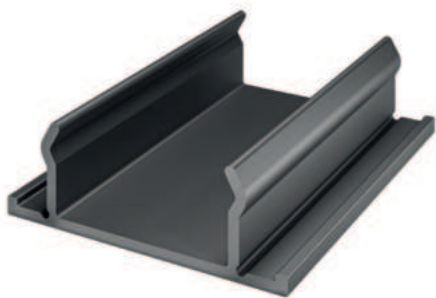

Glazen Dragerprofiel

Product Code	2025
Gewicht (kg/mt)	0,176



Muurprofiel Afdekking

Product Code	2026
Gewicht (kg/mt)	1,016

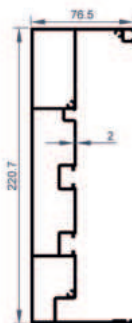

Muurprofiel

Product Code	2027
Gewicht (kg/mt)	4,179

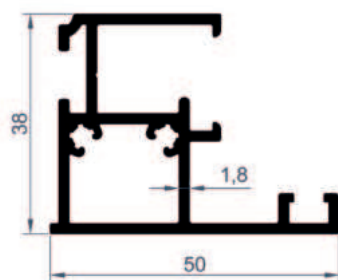

Glazen Drager Strut Joint Profiel

Product Code	2028
Gewicht (kg/mt)	0,848

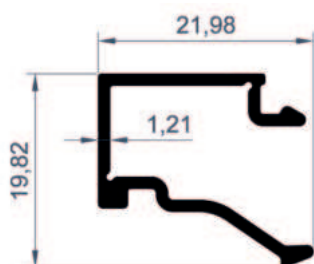
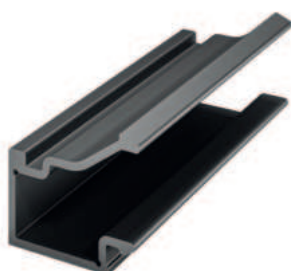

Glazen Drager Strut Joint Spacer Profiel

Product Code	2029
Gewicht (kg/mt)	0,203

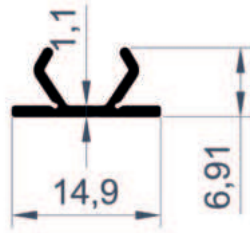

Dakgoot En Steunprofiel



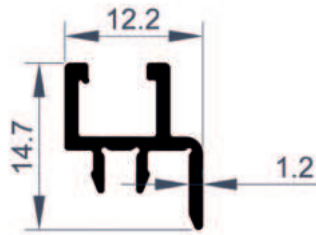
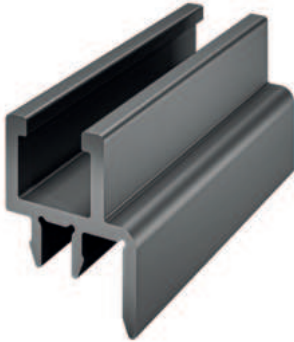





Product Code	2030
Gewicht (kg/mt)	0,079

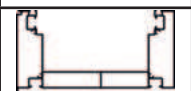
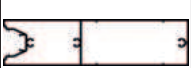

Goot En Wandafdekprofiel

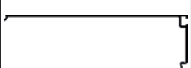
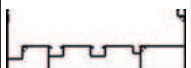
Product Code	2031
Gewicht (kg/mt)	0,117



BQB Veranda Serie Profielen			
Afbeelding.	Profielnr.	Profiel Beschrijving	Kg / mt
	2020	Stut Afdekprofiel	2,528
	2021	Stutprofiel	5,030
	2022	Gootvoegprofiel	2,913
	2023	Gootprofiel	5,168
	2024	Glazen Dragerprofiel	3,501
	2025	Glazen Dragerprofiel	0,176
	2026	Muurprofiel Afdekking	1,016
	2027	Muurprofiel	4,179
	2028	Glazen Drager Strut Joint Profiel	0,848
	2029	Glazen Drager Strut Joint Spacer Profiel	0,203
	2030	Dakgoot En Steunprofiel	0,079
	2031	Goot En Wandafdekprofiel	0,117



STANDAARD SCHUIF SERIE



BEPRO





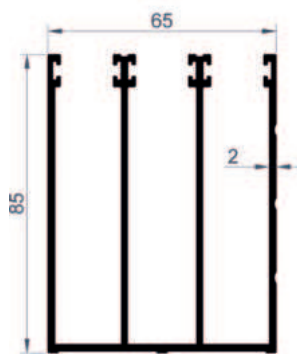

3-Railprofiel

Product Code	2300
Gewicht (kg/mt)	2,209

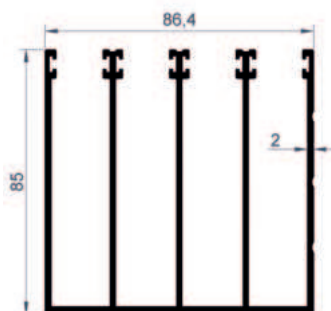

4-Railprofiel

Product Code	2301
Gewicht (kg/mt)	2,789

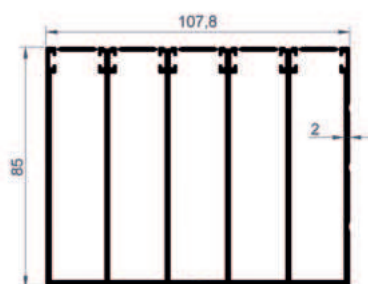
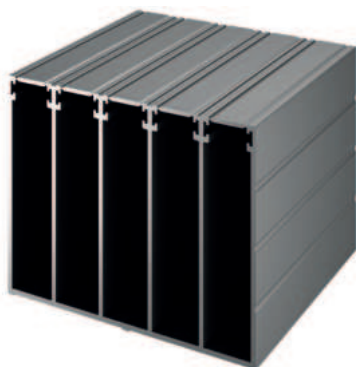

5-Railprofiel

Product Code	2302
Gewicht (kg/mt)	3,661

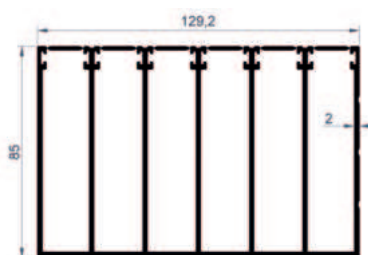
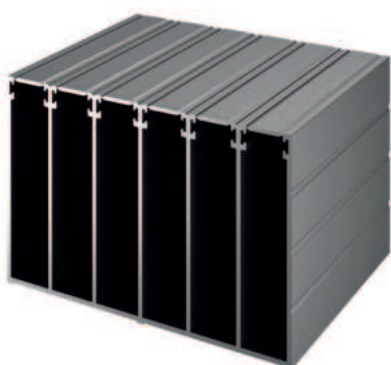

6-Railprofiel

Product Code	2303
Gewicht (kg/mt)	4,298

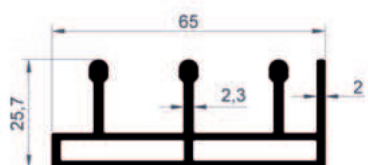
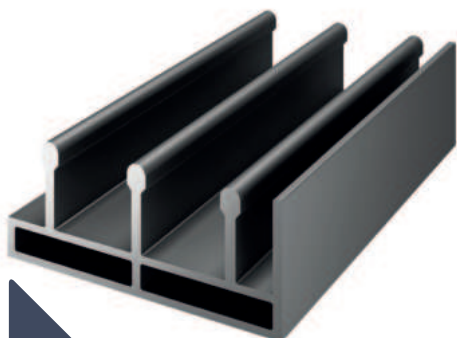

Onderste 3-Rail Profiel

Product Code	2304
Gewicht (kg/mt)	1,138

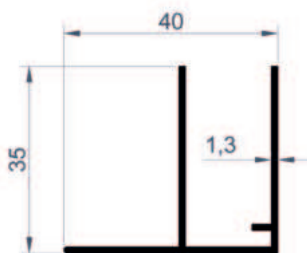

(F) Profiel

Product Code	2305
Gewicht (kg/mt)	0,377

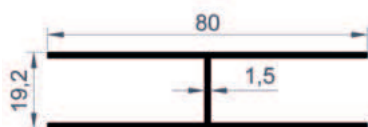
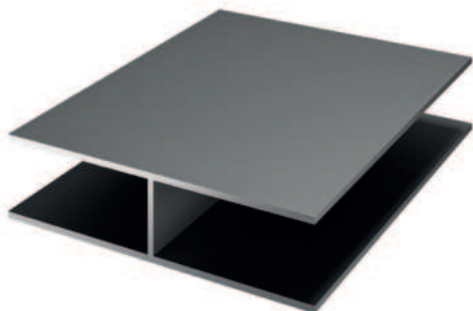

(H) Profiel

Product Code	2306
Gewicht (kg/mt)	0,715

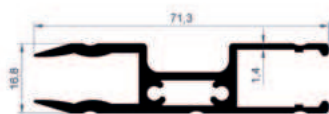

Onderste Sokkelprofiel

Product Code	2307
Gewicht (kg/mt)	0,916

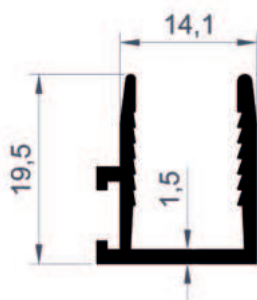

Profiel Zijstijl

Product Code	2308
Gewicht (kg/mt)	0,222

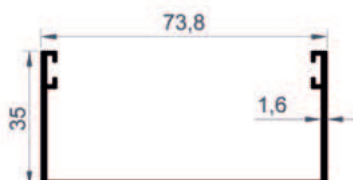

Zijstijl 3 Rail Profiel

Product Code	2309
Gewicht (kg/mt)	0,661

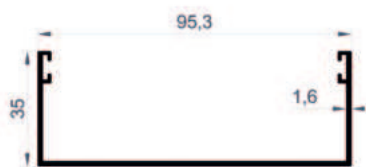

Zijstijl 4-Rail Profiel

Product Code	2310
Gewicht (kg/mt)	0,756



Onderste 4 Rail Profiel

Product Code	2311
Gewicht (kg/mt)	1,558

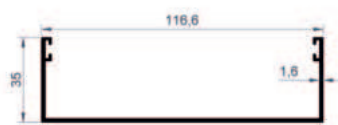

Zijstijl 5-Rail Profiel

Product Code	2312
Gewicht (kg/mt)	0,848

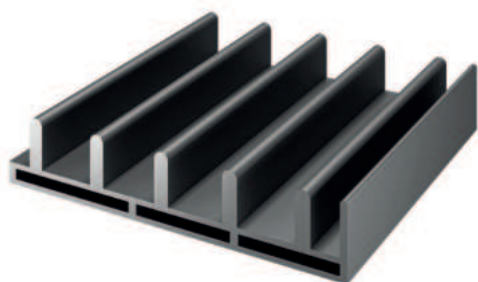

Onderste 5-Rail Profiel

Product Code	2313
Gewicht (kg/mt)	1,943



Zijstijl 6-Rail Profiel

Product Code	2314
Gewicht (kg/mt)	0,864

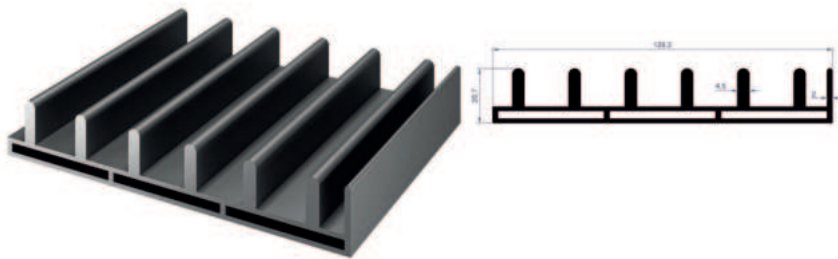

Onderste 6-Rail Profiel

Product Code	2315
Gewicht (kg/mt)	2,287



Lambiri Profiel

Product Code	2316
Gewicht (kg/mt)	1,382



Kulp Profiel

















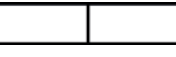

Product Code	2317
Gewicht (kg/mt)	1,019

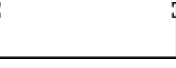

Kulp Profiel

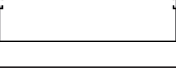
Product Code	2318
Gewicht (kg/mt)	1,111

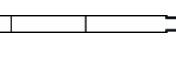

Standaard Schuif Serie Profielen			
Afbeelding.	Profielnr.	Profiel Beschrijving	Kg / mt
	2300	3-Railprofiel	2,209
	2301	4-Railprofiel	2,789
	2302	5-Railprofiel	3,661
	2303	6-Railprofiel	4,298
	2304	Onderste 3-Rail Profiel	1,138
	2305	(F) Profiel	0,377
	2306	(H) Profiel	0,715
	2307	Onderste Sokkelprofiel	0,916
	2308	Profiel Zijstijl	0,222
	2309	Zijstijl 3 Rail Profiel	0,661
	2310	Zijstijl 4-Rail Profiel	0,756
	2311	Onderste 4 Rail Profiel	1,558
	2312	Zijstijl 5-Rail Profiel	0,848
	2313	Onderste 5-Rail Profiel	1,943
	2314	Zijstijl 6-Rail Profiel	0,864
	2315	Onderste 6-Rail Profiel	2,287
	2316	Lambiri Profiel	1,382
	2317	Kulp Profiel	1,019
	2318	Kulp Profiel	1,111

DIAMANT SCHUIF SERIE



 **BEPRO**





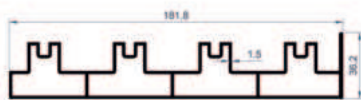
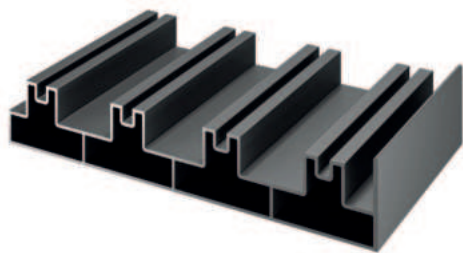

4 Rails Onder- En Bovenprofiel

Product Code	2320
Gewicht (kg/mt)	2,512

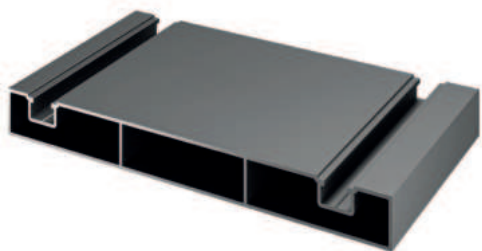

4 Zijstijl Profiel

Product Code	2321
Gewicht (kg/mt)	1,889

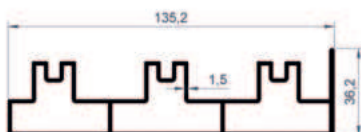
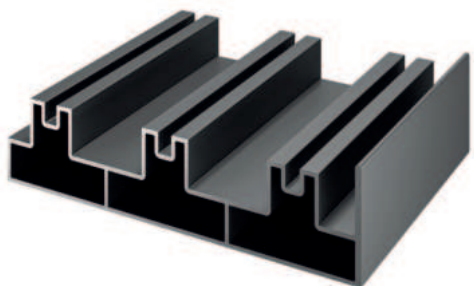

3-Delig Railonder- En Bovenprofiel

Product Code	2322
Gewicht (kg/mt)	1,919

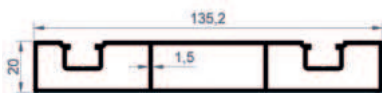
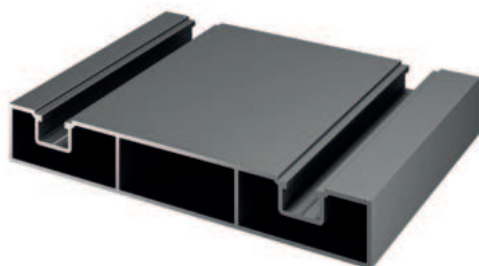

3 Zijstijl Profiel

Product Code	2323
Gewicht (kg/mt)	1,523

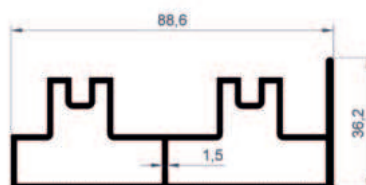
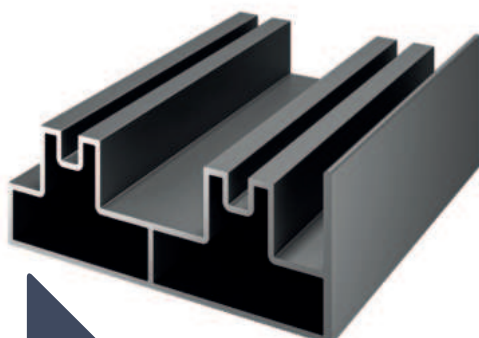

2 Rail Bodem- En Bovenprofiel

Product Code	2324
Gewicht (kg/mt)	1,328

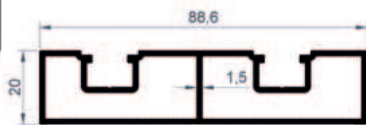
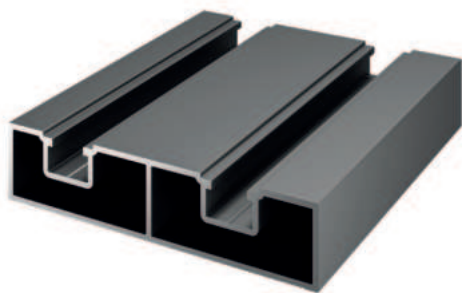

2 Zijstijl Profiel

Product Code	2325
Gewicht (kg/mt)	1,087

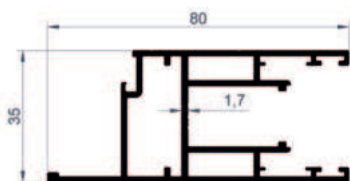
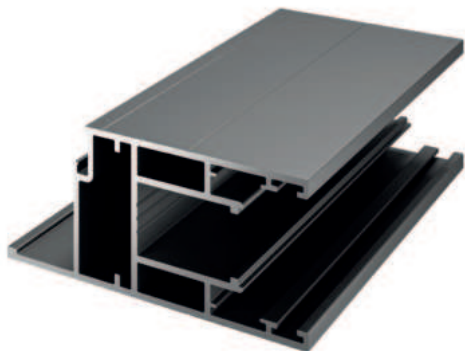

Profiel Schuifraam

Product Code	2326
Gewicht (kg/mt)	1,236

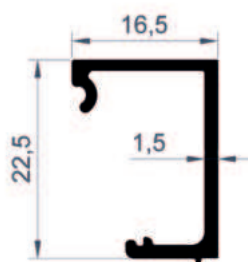

8 Mm En 10 Mm Beglazingsprofiel

Product Code	2327
Gewicht (kg/mt)	0,201

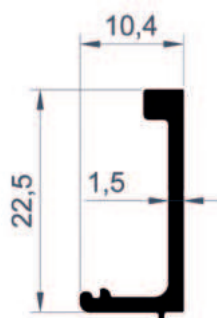

20 Mm Beglazingsprofiel

Product Code	2328
Gewicht (kg/mt)	0,154

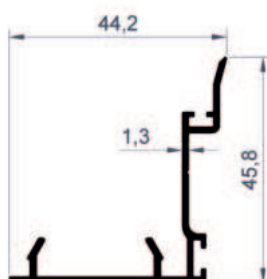

Profiel Kozijnklem

Product Code	2329
Gewicht (kg/mt)	0,417

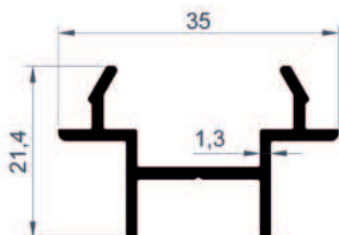
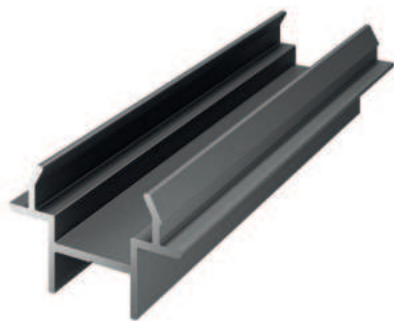

Midden Slot Profiel

Product Code	2330
Gewicht (kg/mt)	0,287

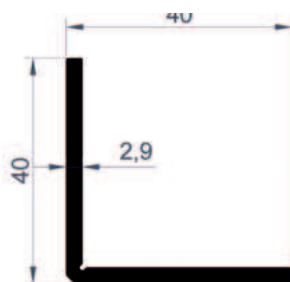

Paneel Hoekwig Profiel

Product Code	2331
Gewicht (kg/mt)	0,591



Wielrail Profiel



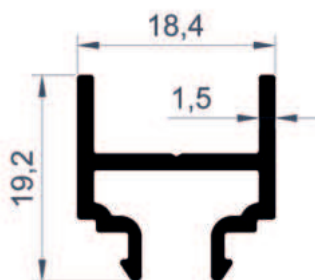







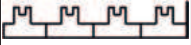

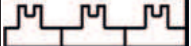
Product Code	2332
Gewicht (kg/mt)	0,130

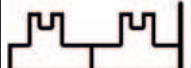
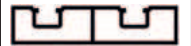

Spagnolet Sluitprofiel

Product Code	2333
Gewicht (kg/mt)	0,241



Diamant Schuifprofielen			
Afbeelding.	Profielnr.	Profiel Beschrijving	Kg / mt
	2320	4 RAILS ONDER- EN BOVENPROFIEL	2,512
	2321	4 ZIJSTIJL PROFIEL	1,889
	2322	3-DELIG RAILONDER- EN BOVENPROFIEL	1,919
	2323	3 ZIJSTIJL PROFIEL	1,523
	2324	2 RAIL BODEM- EN BOVENPROFIEL	1,328
	2325	2 ZIJSTIJL PROFIEL	1,087
	2326	PROFIEL SCHUIFRAAM	1,236
	2327	8 MM EN 10 MM BEGLAZINGSPROFIEL	0,201
	2328	20 MM BEGLAZINGSPROFIEL	0,154
	2329	PROFIEL KOZIJNKLEM	0,417
	2330	MIDDEN SLOT PROFIEL	0,287
	2331	PANEEL HOEKWIG PROFIEL	0,591
	2332	WIELRAIL PROFIEL	0,130
	2333	SPAGNOLET SLUITPROFIEL	0,241

STANDAARD PROFIELEN



40

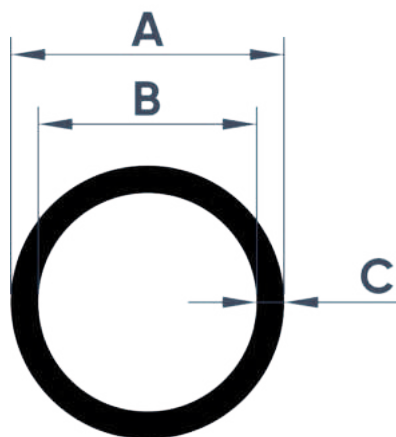

Profielnr.	A(mm)	B(mm)	C(mm)	kg/mt
1102	6	4	1	0,044
1103	8	6	1	0,060
1104	10	8	1	0,079
1105	10	7	1,5	0,111
1106	12	9	1,5	0,136
1100	16	14	1	0,132
1108	16	13	1,5	0,187
1109	19	16,6	1,2	0,185
1110	20	18	1	0,163
1111	22	20	1	0,179
1112	25	22,6	1,2	0,244
1113	25	21,4	1,8	0,360
1114	28	26	1	0,230
1115	32	29,6	1,2	0,318
1116	32	29	1,5	0,391
1117	32	28	2	0,513
1118	35	31,6	1,7	0,483
1119	35	31	2	0,564
1120	40	37,4	1,3	0,431
1121	42	38	2	0,683
1100	50	47,4	1,3	0,540
1122	60,1	56,9	1,6	0,799

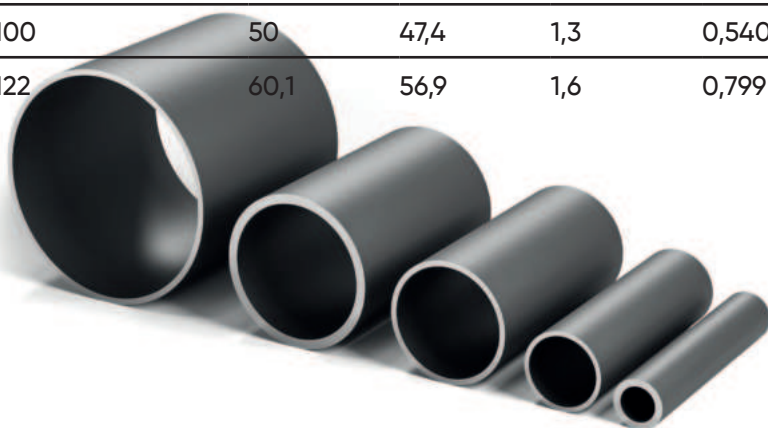



Profielnr.	A(mm)	B(mm)	C(mm)	kg/mt
1005	14	14	1,5	0,204
1006	15	30	1	0,233
1007	16	16	1,4	0,220
1008	17	25	1	0,217
1009	20	40	1,8	0,543
1010	20	20	1,5	0,301
1011	20	60	2	0,824
1012	20	40	1,3	0,404
1013	25	25	1,2	0,309
1014	25	80	1,2	0,666
1015	25	40	1,4	0,475
1016	30	30	1,2	0,374
1017	30	50	2	0,824
1018	30	70	1,5	0,789
1003	40	60	1,2	0,660
1002	40	40	1,1	0,481
2155	40	40	2	0,857
4154	40	80	2	1,257
4155	40	100	2	1,474
1021	50	130	1,4	1,347
1001	50	100	1,8	1,427
1022	60	60	2	1,261
1023	140	60	1,5	1,645

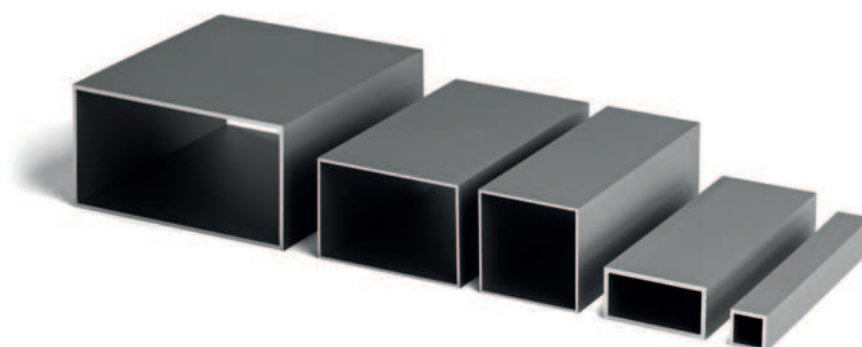

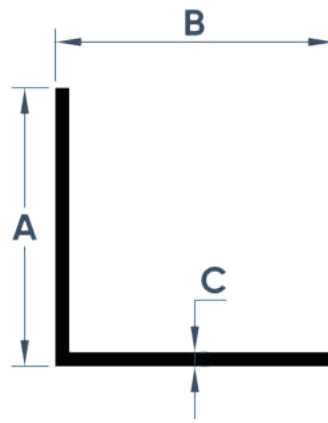

Profielnr.	A(mm)	B(mm)	C(mm)	kg/mt
1053	20	20	1,2	0,044
1050	20	40	1,2	0,060
1054	20	50	1,2	0,079
1051	20	60	1,2	0,111
1055	20	80	1,4	0,136
1056	25	25	1,2	0,132
1057	30	30	2	0,187
1058	50	50	1,5	0,185
G10000	39,9	39,9	2,85	0,163
1052	40	40	1,2	0,179
1059	40	40	2	0,244

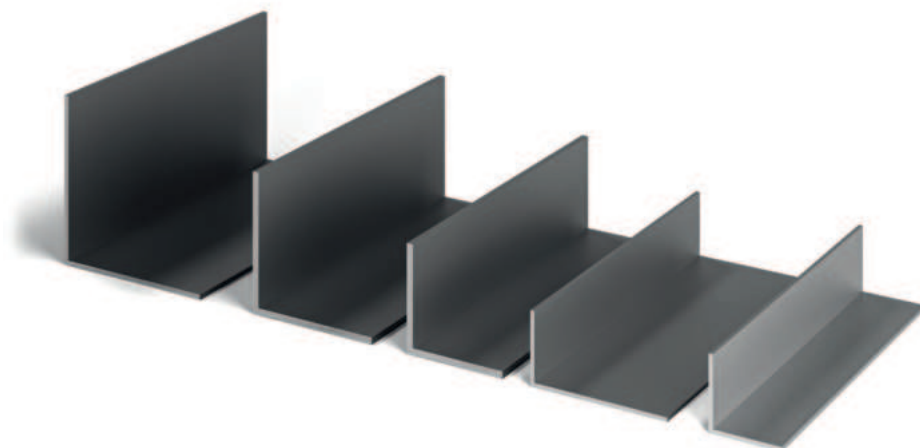

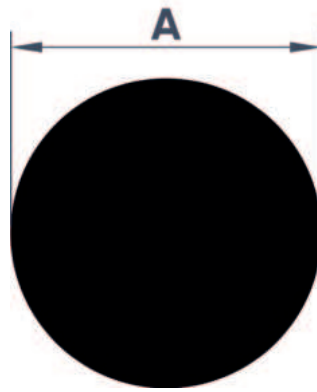

Profielnr.	A _(mm)	kg/mt
1070	8	0,136
1071	10	0,215
1072	16	0,548
1073	20	0,851
1074	25	1,328
1075	30	1,916
1076	35	2,610
1077	40	3,407
1078	45	4,309
1079	50	5,325
1080	55	6,440
1081	59	7,662



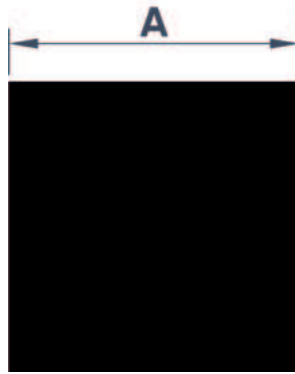

Profielnr.	A _(mm)	kg/mt
1090	5	0,068
1091	6	0,095
1092	25	1,696
1093	30	2,440
1094	40	4,336
1095	50	6,775
1096	60	9,756
1097	80	17,344
1098	90	21,951
1099	100	27,100

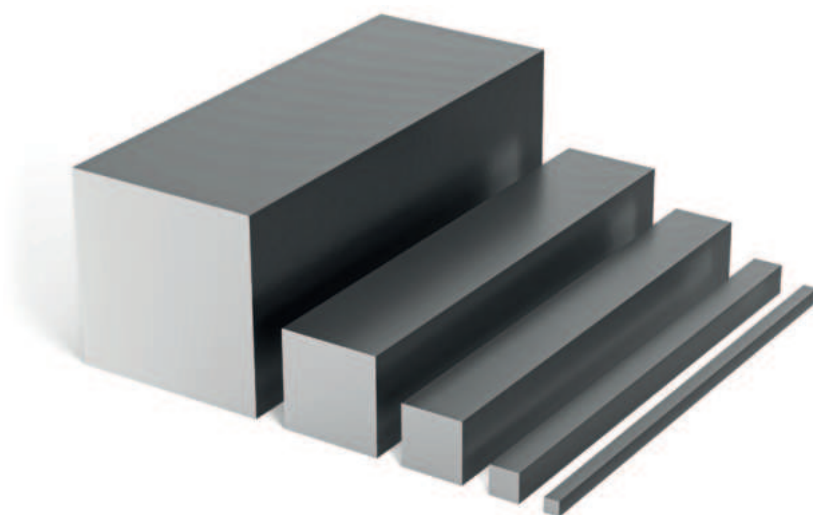



SCHUTTING SERIE

 **BEPRO**





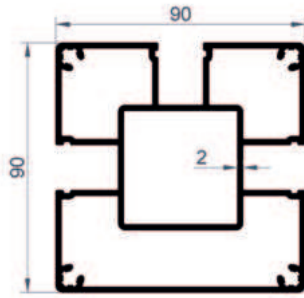

Stutprofiel

Product Code	2144
Gewicht (kg/mt)	3,488



Paneel Profiel

Product Code	2145
Gewicht (kg/mt)	1,420

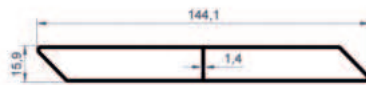

Paneel Profiel

Product Code	2146
Gewicht (kg/mt)	1,141

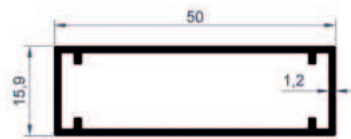
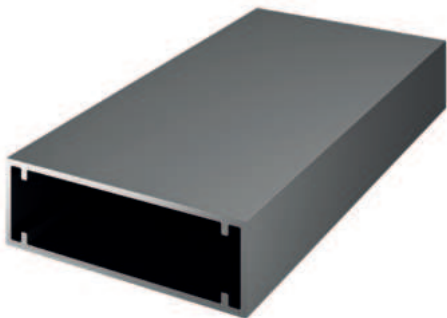

Doos Profiel

Product Code	2147
Gewicht (kg/mt)	0,442

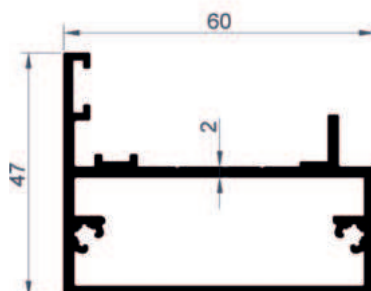
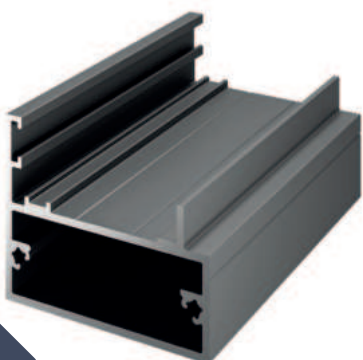

Deur Zijframe Stutprofiel

Product Code	2148
Gewicht (kg/mt)	1,236

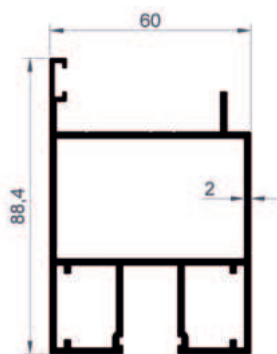

Profiel Deur Zijframe

Product Code	2149
Gewicht (kg/mt)	2,076

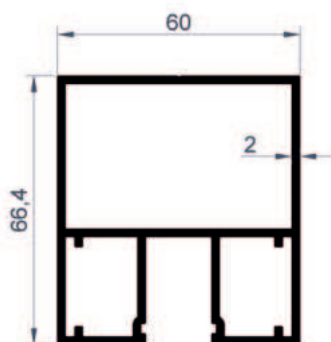

Profiel Onderkozijn Boven

Product Code	2150
Gewicht (kg/mt)	1,875

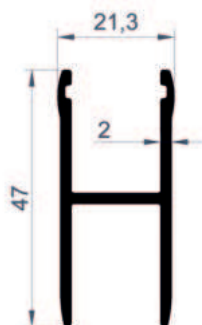

Glaspaneel Profiel

Product Code	2151
Gewicht (kg/mt)	0,585

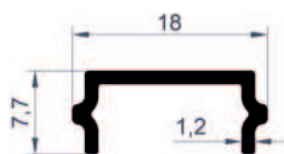
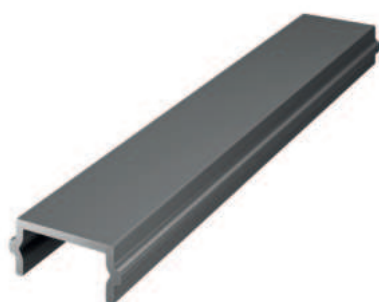

Stut Afdekprofiel

Product Code	2152
Gewicht (kg/mt)	0,100

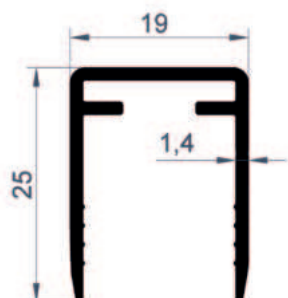

Paneel Afdekprofiel

Product Code	2153
Gewicht (kg/mt)	0,263

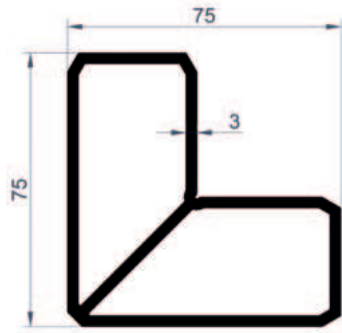
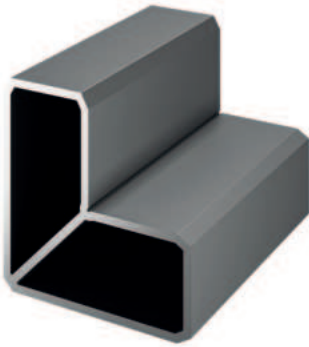

Hoek Profiel Deurkozijn



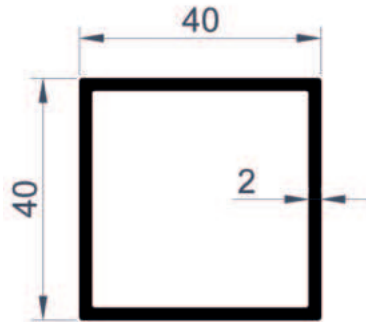
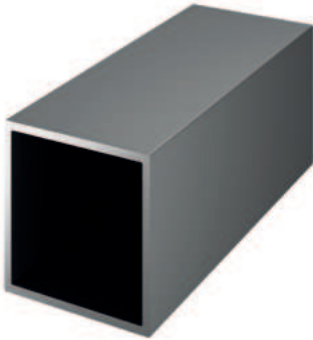







Product Code	2154
Gewicht (kg/mt)	2,607

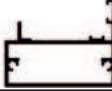

Doos Profiel

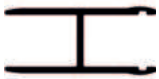
Product Code	2155
Gewicht (kg/mt)	0,824



Schutting Serie Profielen			
Afbeelding.	Profielnr.	Profiel Beschrijving	Kg / mt
	2144	Stutprofiel	3,488
	2145	Paneel Profiel	1,420
	2146	Paneel Profiel	1,141
	2147	Doos Profiel	0,442
	2148	Deur Zijframe Stutprofiel	1,236
	2149	Profiel Deur Zijframe	2,076
	2150	Profiel Onderkozijn Boven	1,875
	2151	Glaspaneel Profiel	0,585
	2152	Stut Afdekprofiel	0,100
	2153	Paneel Afdekprofiel	0,263
	2154	Hoek Profiel Deurkozijn	2,607
	2155	Doos Profiel	0,824



GEMOTORISEERDE BIOCLIMATIC SERIE



 **BEPRO**

55





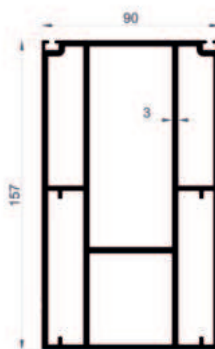

Middenrail Steunprofiel

Product Code	2092
Gewicht (kg/mt)	7,003



Paneel Profiel

Product Code	2093
Gewicht (kg/mt)	3,396

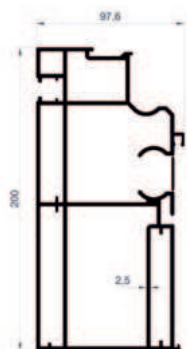

Zijrail Profiel

Product Code	2094
Gewicht (kg/mt)	7,336

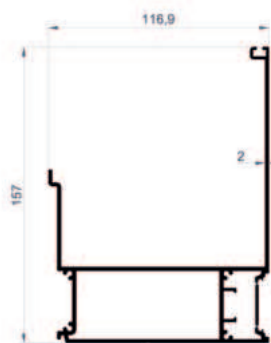

Rail Groef Voeg Profiel

Product Code	2095
Gewicht (kg/mt)	2,978

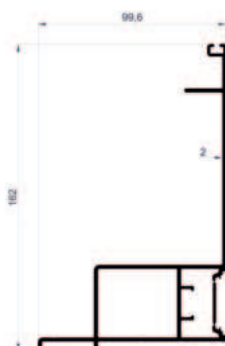

Gootvoeg Profiel

Product Code	2096
Gewicht (kg/mt)	2,415

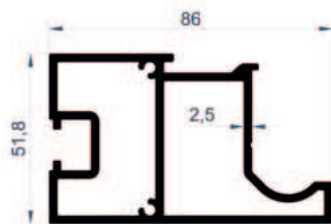

(C) Gootprofiel

Product Code	2097
Gewicht (kg/mt)	2,393

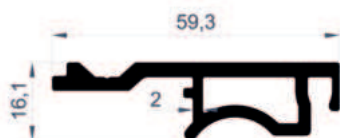
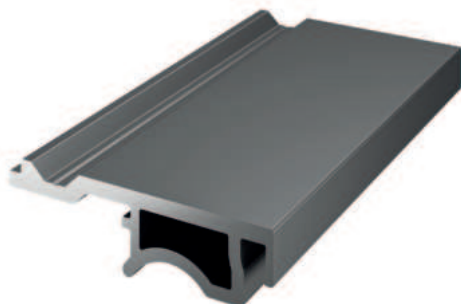

Profiel Afdekking Rail En (C-)Goot

Product Code	2098
Gewicht (kg/mt)	0,873

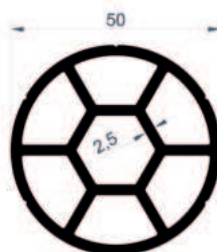

Motortransmissie 6'Gen As Profiel 1

Product Code	2099
Gewicht (kg/mt)	1,878

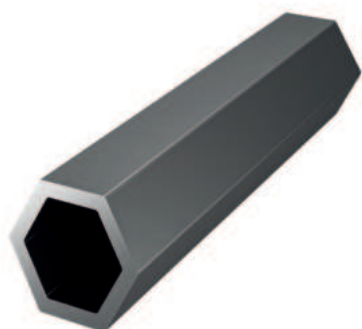

Motortransmissie 6'Gen As Profiel 2

Product Code	2100
Gewicht (kg/mt)	0,453



Motortransmissie 6'Gen As Profiel 3

Product Code	2101
Gewicht (kg/mt)	0,602

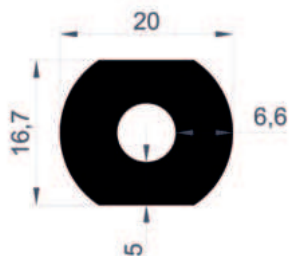

Motortransmissie 6'Gen As Profiel 4

Product Code	2103
Gewicht (kg/mt)	0,686



Goot Top Registratie Profiel

Product Code	2112
Gewicht (kg/mt)	3,745

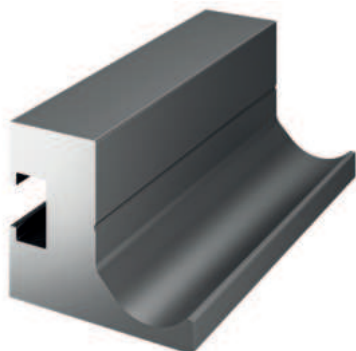

Motortransmissie 6'Gen As Profiel 5

Product Code	2156
Gewicht (kg/mt)	2,564



2 Modules x24 Draad

Product Code	2157
Gewicht (kg/mt)	3,705



2 Modules x36 Draad

Product Code	2158
Gewicht (kg/mt)	6,762



Profiel Rail Zijafsluiting 1













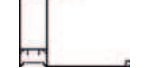



Product Code	2159
Gewicht (kg/mt)	1,797



Profiel Rail Zijafsluiting 2

Product Code	2160
Gewicht (kg/mt)	0,930



Gemotoriseerde Bioclimatic Serie Profielen			
Afbeelding.	Profielnr.	Profiel Beschrijving	Kg / mt
	2092	Middenrail Steunprofiel	7,003
	2093	Paneel Profiel	3,396
	2094	Zijrail Profiel	7,336
	2095	Rail Groef Voeg Profiel	2,978
	2096	Gootvoeg Profiel	2,415
	2097	(C) Gootprofiel	2,393
	2098	Profiel Afdekking Rail En (C-)Goot	0,873
	2099	Motortransmissie 6'Gen As Profiel 1	1,878
	2100	Motortransmissie 6'Gen As Profiel 2	0,453
	2101	Motortransmissie 6'Gen As Profiel 3	0,602
	2103	Motortransmissie 6'Gen As Profiel 4	0,686
	2112	Goot Top Registratie Profiel	3,745
	2156	Motortransmissie 6'Gen As Profiel 5	2,564
	2317	2 Modules x24 Draad	3,705
	2158	2 Modules x36 Draad	6,762
	2159	Profiel Rail Zijafsluiting 1	1,715
	2160	Profiel Rail Zijafsluiting 2	0,930

HANDMATIGE BIOCLIMATIC SERIE



 **BEPRO**





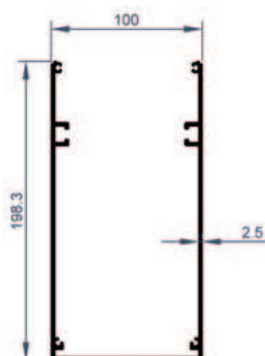

Stutprofiel

Product Code	2104
Gewicht (kg/mt)	3,835



Draagprofiel Voor En Zijkant

Product Code	2105
Gewicht (kg/mt)	5,233

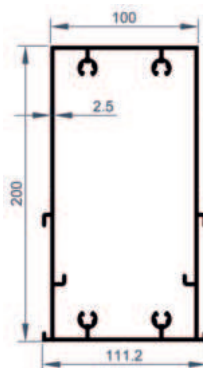

Midden Draagprofiel

Product Code	2106
Gewicht (kg/mt)	5,461

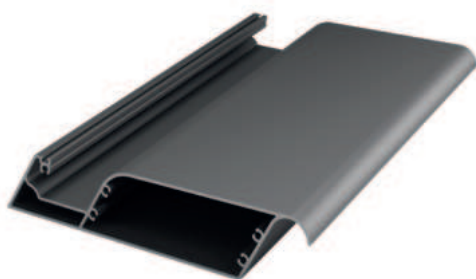

Paneel Profiel

Product Code	2107
Gewicht (kg/mt)	2,317

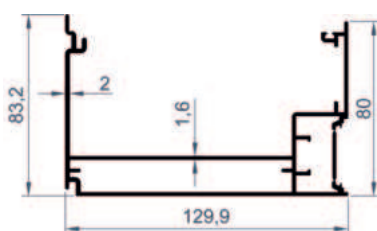

Gootprofiel

Product Code	2108
Gewicht (kg/mt)	2,355

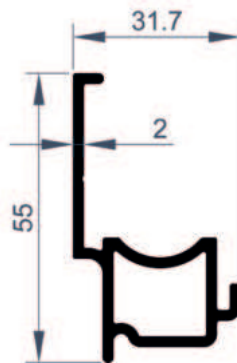

Railprofiel

Product Code	2109
Gewicht (kg/mt)	0,729

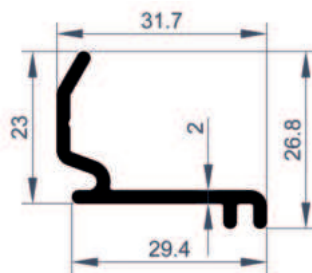
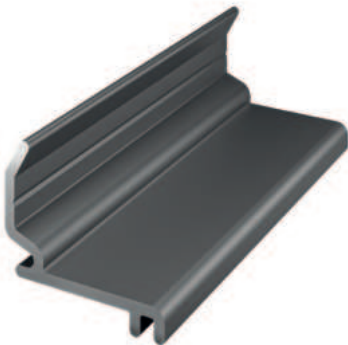

Rail Afdekprofiel

Product Code	2110
Gewicht (kg/mt)	0,331

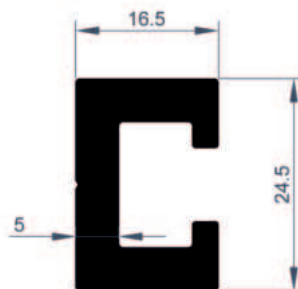

Paneel Boven Verbindingsprofiel



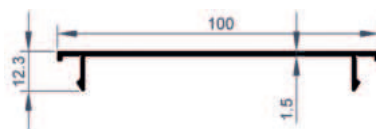
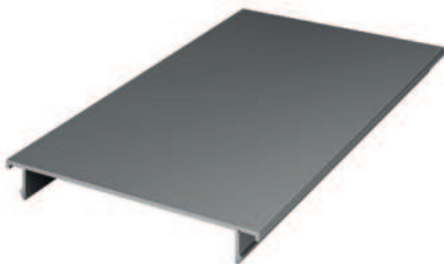





Product Code	2111
Gewicht (kg/mt)	0,691

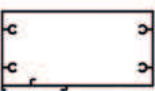

Verankeringsprofiel Onderbalk

Product Code	2113
Gewicht (kg/mt)	0,501



Handmatige Bioclimatic Serie Profielen			
Afbeelding.	Profielnr.	Profiel Beschrijving	Kg / mt
	2104	Stutprofiel	3,835
	2105	Draagprofiel Voor En Zijkant	5,233
	2106	Midden Draagprofiel	5,461
	2107	Paneel Profiel	2,317
	2108	Gootprofiel	2,355
	2109	Railprofiel	0,729
	2110	Rail Afdekprofiel	0,331
	2111	Paneel Boven Verbindingsprofiel	0,691
	2113	Verankeringsprofiel Onderbalk	0,501

PLAFONDGORDIJN SERIE

 **BEPRO**

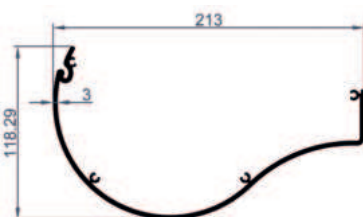

Motorist Profiel

Product Code	2080
Gewicht (kg/mt)	3,133

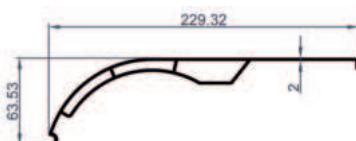
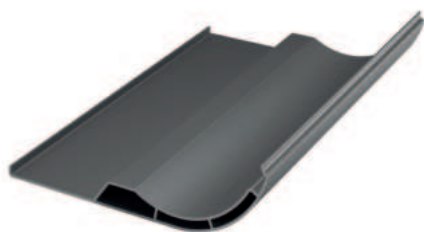

Motorist Afdekprofiel

Product Code	2081
Gewicht (kg/mt)	2,412

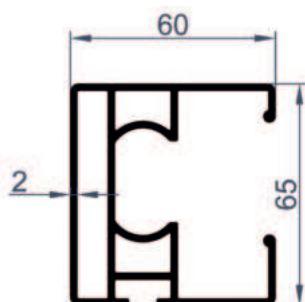
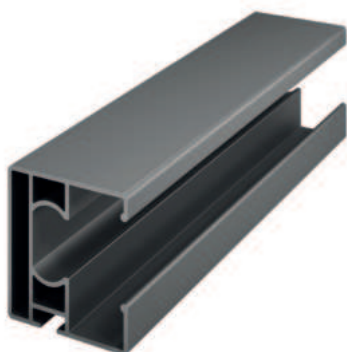

Railprofiel

Product Code	2082
Gewicht (kg/mt)	1,916

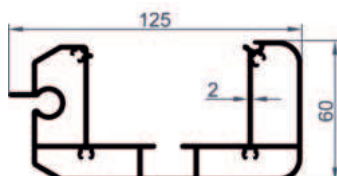

Front Trekhaak Profiel

Product Code	2083
Gewicht (kg/mt)	2,873

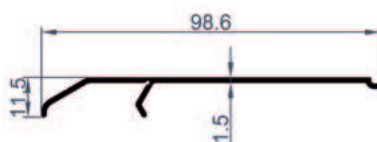

Front Afdekprofiel

Product Code	2084
Gewicht (kg/mt)	0,463

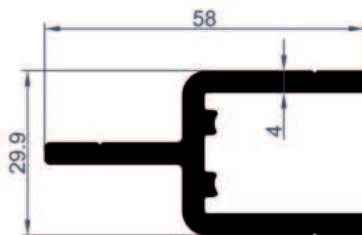

Profiel Enkele Veerspanner

Product Code	2085
Gewicht (kg/mt)	1,247

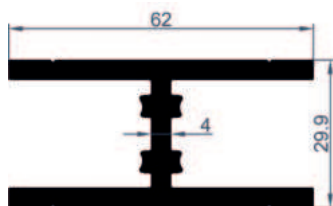

Profiel Dubbele Veerspanner



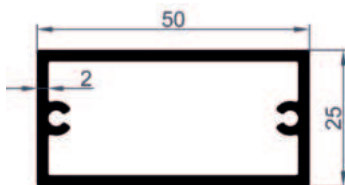



Product Code	2086
Gewicht (kg/mt)	1,677

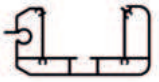

Profiel Veerpot

Product Code	2087
Gewicht (kg/mt)	0,840



Plafondgordijn Serie Profielen			
Afbeelding.	Profielnr.	Profiel Beschrijving	Kg / mt
	2080	Motorist Profiel	3,133
	2081	Motorist Afdekprofiel	2,412
	2082	Railprofiel	1,916
	2083	Front Trekhaak Profiel	2,873
	2084	Front Afdekprofiel	0,463
	2085	Profiel Enkele Veerspanner	1,247
	2086	Profiel Dubbele Veerspanner	1,677
	2087	Profiel Veerpot	0,840

C60 SERIE

 BEPRO

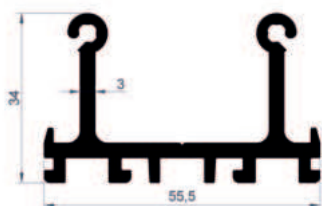

Verticale Aansluiting, Adapterprofiel

Product Code	1516
Gewicht (kg/mt)	1,201

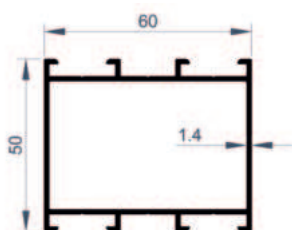

Frame En Kastprofiel

Product Code	1500
Gewicht (kg/mt)	0,959

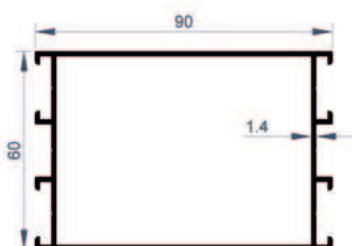

Frame En Kastprofiel

Product Code	1501
Gewicht (kg/mt)	1,262

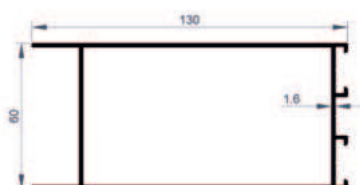

Vast Dorpelprofiel

Product Code	1502
Gewicht (kg/mt)	1,688

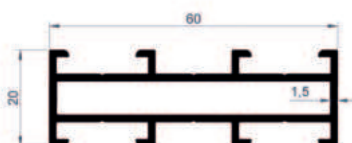

Frame En Kastprofiel

Product Code	1503
Gewicht (kg/mt)	0,767

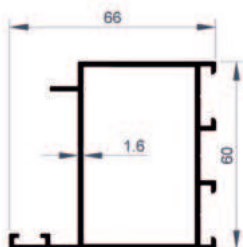
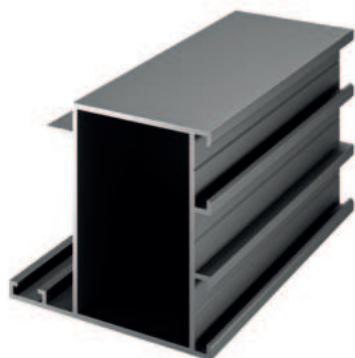

Deurvleugelprofiel

Product Code	1504
Gewicht (kg/mt)	1,098

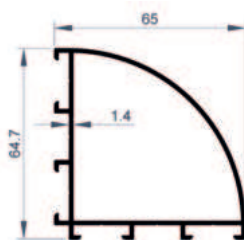
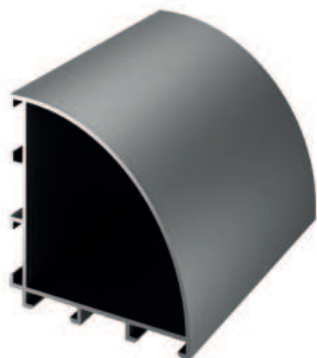

Hoekprofiel

Product Code	1505
Gewicht (kg/mt)	1,016

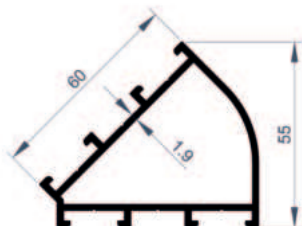
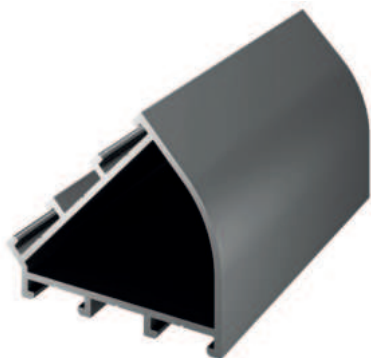

Hoekprofiel

Product Code	1506
Gewicht (kg/mt)	1,173

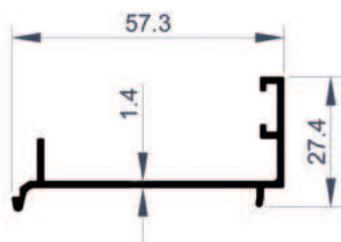

Kozijn Adapterprofiel

Product Code	1507
Gewicht (kg/mt)	0,404

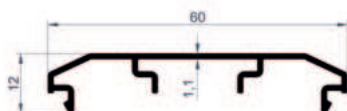
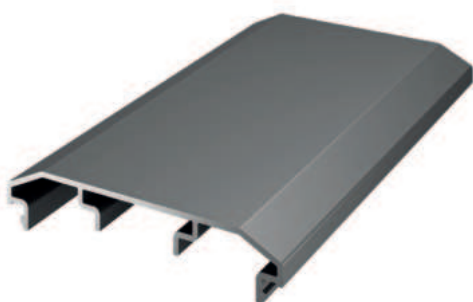

Adapterprofiel Retourframe

Product Code	1508
Gewicht (kg/mt)	0,317

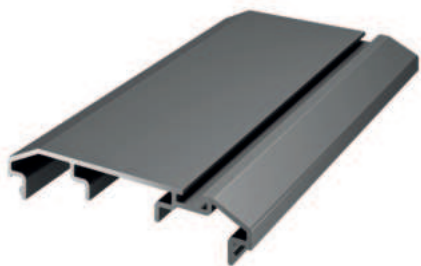

Adapterprofil Retourframe

Product Code	1509
Gewicht (kg/mt)	0,333

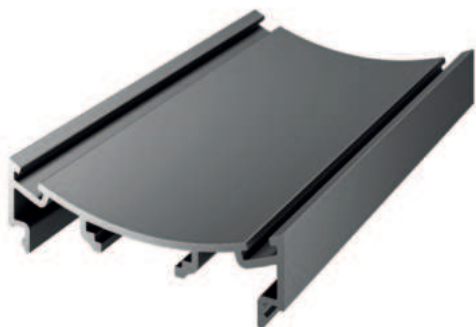

Adapterprofil Retourframe

Product Code	1510
Gewicht (kg/mt)	0,478

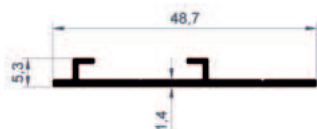

Venster Adapterprofiel

Product Code	1511
Gewicht (kg/mt)	0,222



Staaf Profiel

Product Code	1512
Gewicht (kg/mt)	0,108

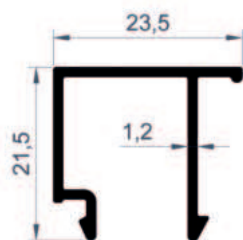

Glasdruppel Profiel

Product Code	1513
Gewicht (kg/mt)	0,233

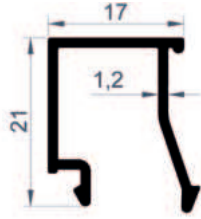



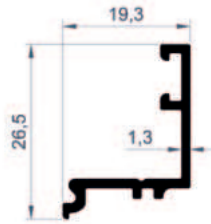





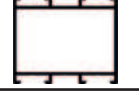

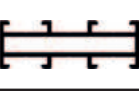



Glasdruppel Profiel	
Product Code	1514
Gewicht (kg/mt)	0,211



Glasdruppel Profiel	
Product Code	1515
Gewicht (kg/mt)	0,205



C60 Serie Profielen			
Afbeelding.	Profielnr.	Profiel Beschrijving	Kg / mt
	1516	Verticale Aansluiting, Adapterprofiel	1,201
	1500	Frame En Kastprofiel	0,959
	1501	Frame En Kastprofiel	1,262
	1502	Vast Dorpelprofiel	1,688
	1503	Frame En Kastprofiel	0,767
	1504	Deurvleugelprofiel	1,098
	1505	Hoekprofiel	1,016
	1506	Hoekprofiel	1,173
	1507	Kozijn Adapterprofiel	0,404
	1508	Adapterprofiel Retourframe	0,317
	1509	Adapterprofiel Retourframe	0,333
	1510	Adapterprofiel Retourframe	0,478
	1511	Venster Adapterprofiel	0,222
	1512	Staaf Profiel	0,108
	1513	Glasdruppel Profiel	0,233
	1514	Glasdruppel Profiel	0,211
	1515	Glasdruppel Profiel	0,205

ALDOKS SERIE

 **BEPRO**

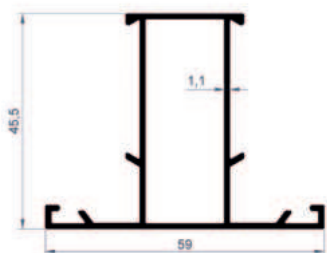

Profiel Smalle Kruisingsrail

Product Code	1550
Gewicht (kg/mt)	0,607

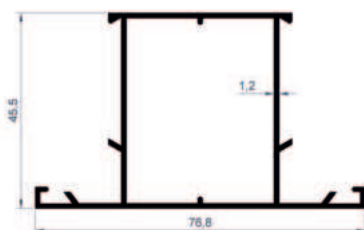

Profiel Smalle Kruisingsrail

Product Code	1551
Gewicht (kg/mt)	0,759

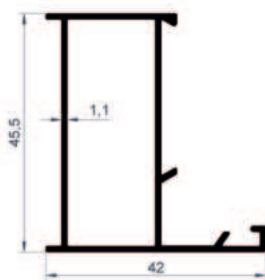

Smal Profiel Frame

Product Code	1552
Gewicht (kg/mt)	0,507

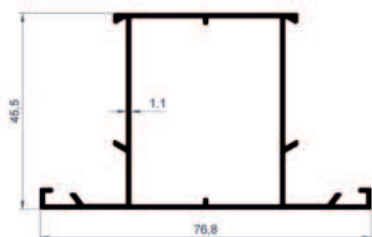

Profiel Kruisrails

Product Code	1553
Gewicht (kg/mt)	0,718

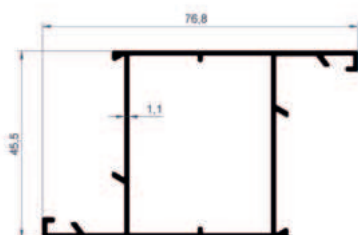

Breed Vleugelprofiel

Product Code	1554
Gewicht (kg/mt)	0,718

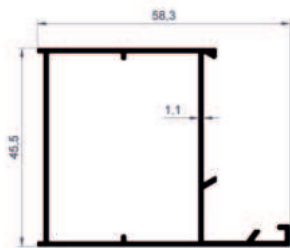
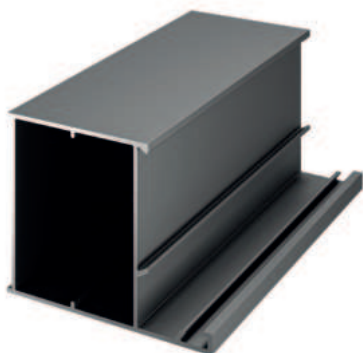

Breed Kokerprofiel

Product Code	1555
Gewicht (kg/mt)	0,615



Profiel Kruisrails

Product Code	1556
Gewicht (kg/mt)	1,122

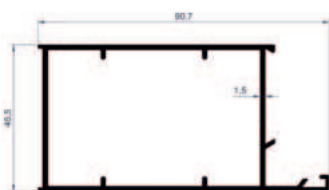
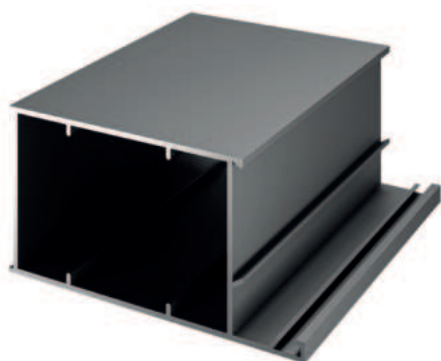

Breed Kokerprofiel

Product Code	1557
Gewicht (kg/mt)	1,087

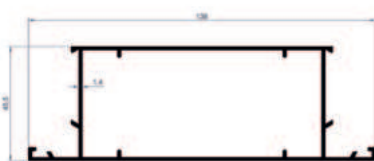

Brede Frame Kruisrail Profiel

Product Code	1558
Gewicht (kg/mt)	1,379

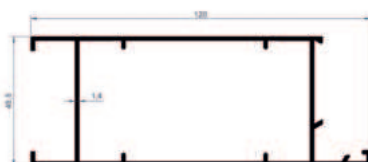

Brede Frame Kruisrail Profiel

Product Code	1559
Gewicht (kg/mt)	1,285

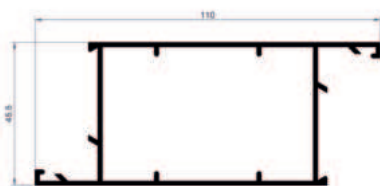

Breed Kokerprofiel

Product Code	1560
Gewicht (kg/mt)	1,176

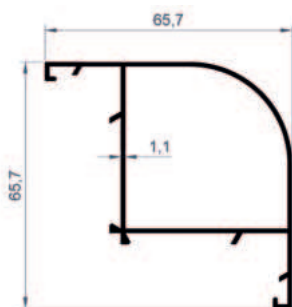

90° Hoekprofiel

Product Code	1561
Gewicht (kg/mt)	0,718

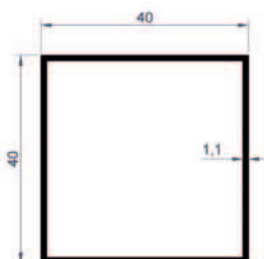

Doos Profiel

Product Code	1562
Gewicht (kg/mt)	0,463

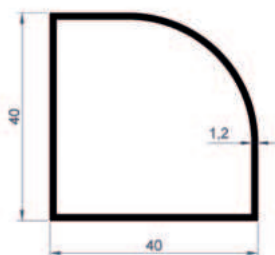
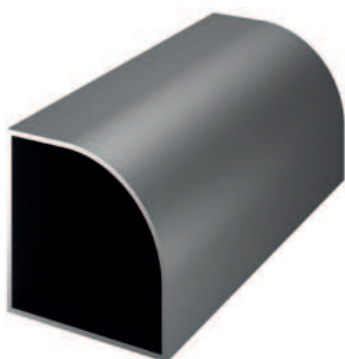

Radius Kokerprofiel

Product Code	1563
Gewicht (kg/mt)	0,472

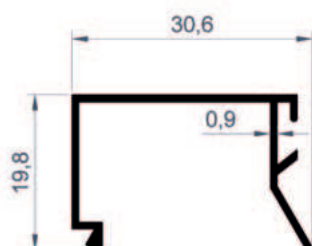
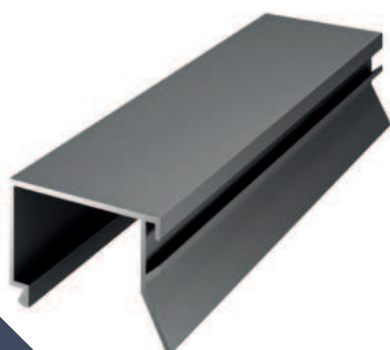

Glaslint Profiel

Product Code	1564
Gewicht (kg/mt)	0,198

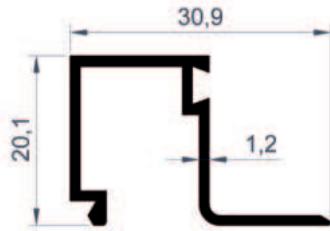
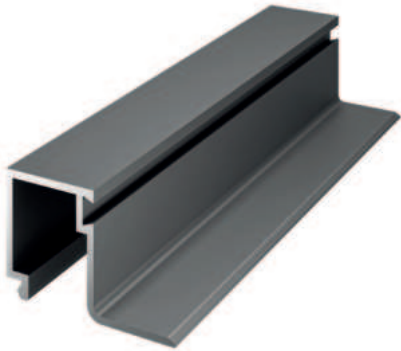

Intervallijsten Profiel

Product Code	1565
Gewicht (kg/mt)	0,249

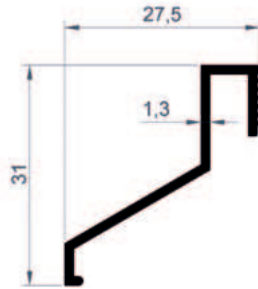

Druppelrand Profiel

Product Code	1566
Gewicht (kg/mt)	0,211

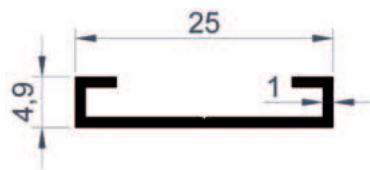

Spagnet Staaf Profiel

Product Code	1567
Gewicht (kg/mt)	0,106

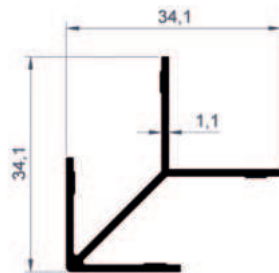

Spagnet Staaf Profiel



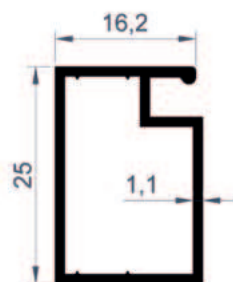





Product Code	1568
Gewicht (kg/mt)	0,285



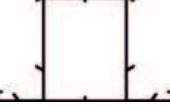

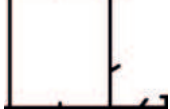

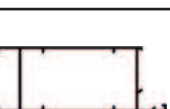

Vliegengas Frame Profiel

Product Code	1569
Gewicht (kg/mt)	0,257

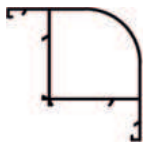
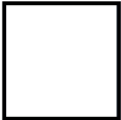
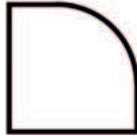

Aldoks Serie Profielen			
Afbeelding.	Profielnr.	Profiel Beschrijving	Kg / mt
	1550	Profiel Smalle Kruisingsrail	0,607
	1551	Profiel Smalle Kruisingsrail	0,759
	1552	Smal Profiel Frame	0,507
	1553	Profiel Kruisrails	0,718
	1554	Breed Vleugelprofiel	0,718
	1555	Breed Kokerprofiel	0,615
	1556	Profiel Kruisrails	1,122
	1557	Breed Kokerprofiel	1,087
	1558	Brede Frame Kruisrail Profiel	1,379
	1559	Brede Frame Kruisrail Profiel	1,285



Afbeelding.	Profielnr.	Profiel Beschrijving	Kg / mt
	1560	Breed Kokerprofiel	1,176
	1561	90° Hoekprofiel	0,718
	1562	Doos Profiel	0,463
	1563	Radius Kokerprofiel	0,472
	1564	Glaslint Profiel	0,198
	1565	Intervallijsten Profiel	0,249
	1566	Druppelrand Profiel	0,211
	1567	Spagnet Staaf Profiel	0,106
	1568	Spagnet Staaf Profiel	0,285
	1569	Vliegengaas Frame Profiel	0,257

DORPEL PROFIELEN

 **BEPRO**

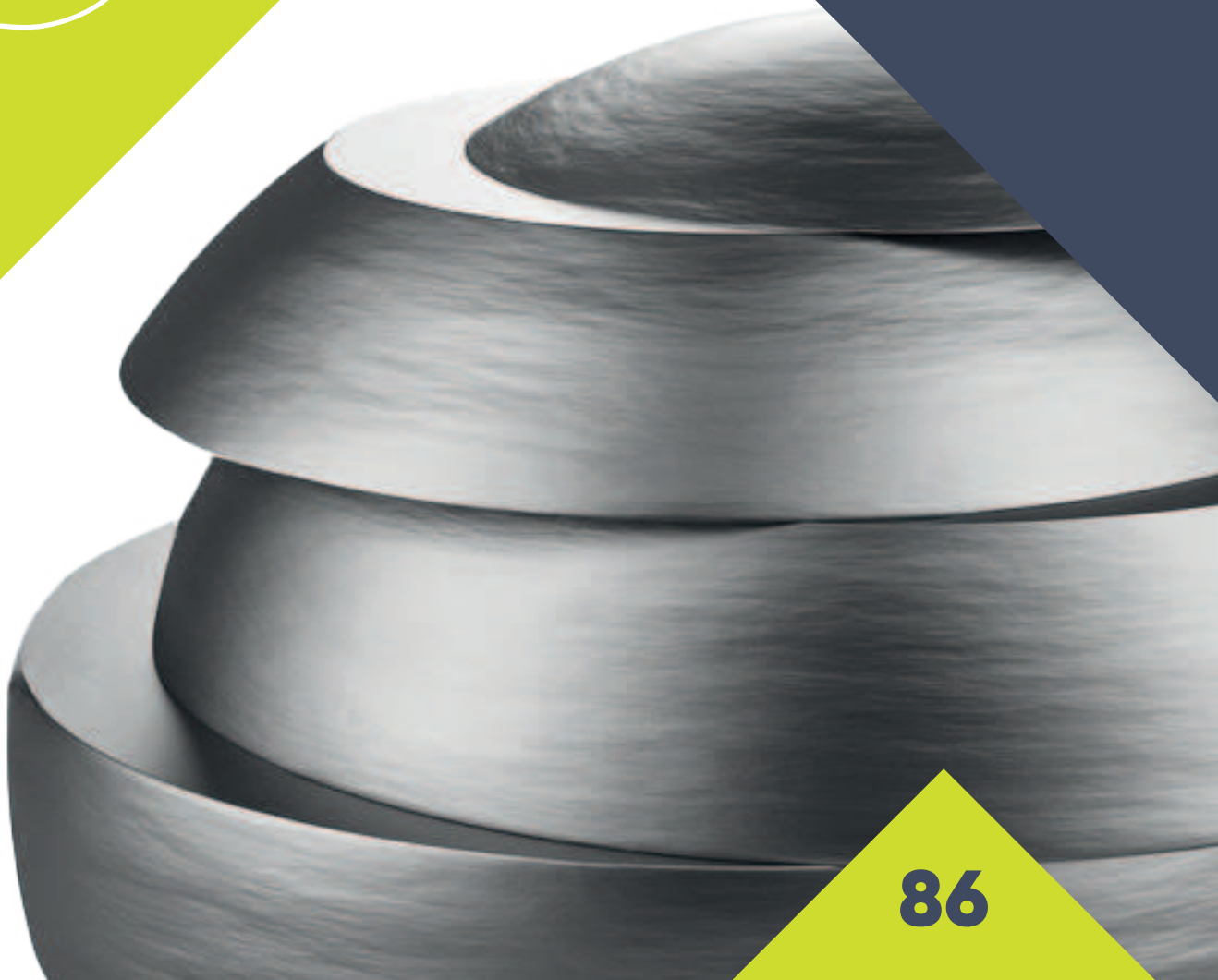

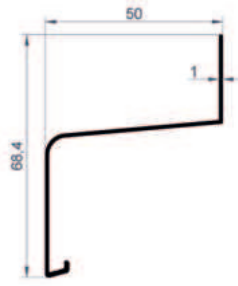

50 Dorpel Profielen

Product Code	3200
Gewicht (kg/mt)	0,328

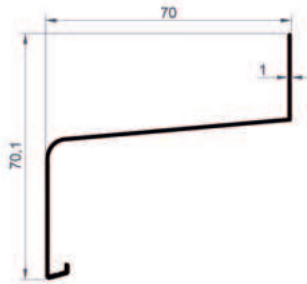
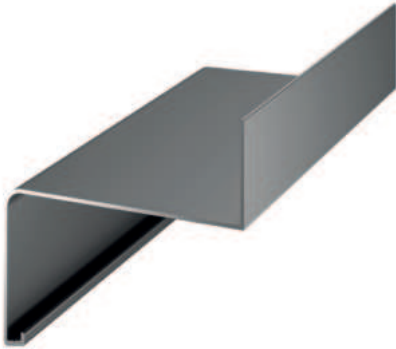

70 Dorpel Profielen

Product Code	3201
Gewicht (kg/mt)	0,382

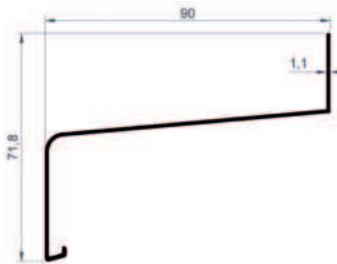
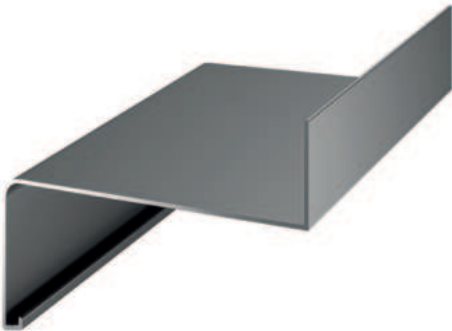

90 Dorpel Profielen

Product Code	3202
Gewicht (kg/mt)	0,477

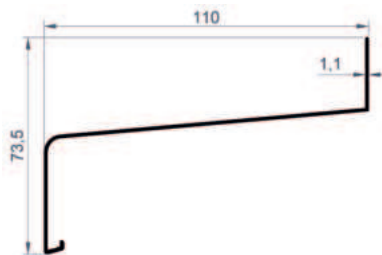
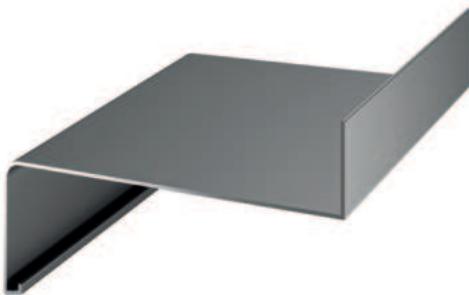

110 Dorpel Profielen

Product Code	3203
Gewicht (kg/mt)	0,537

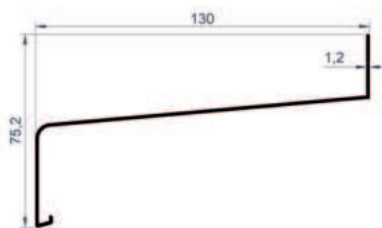

130 Dorpel Profielen

Product Code	3204
Gewicht (kg/mt)	0,648

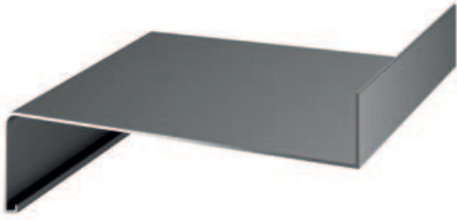

150 Dorpel Profielen

Product Code	3205
Gewicht (kg/mt)	0,740



165 Dorpel Profielen

Product Code	3206
Gewicht (kg/mt)	0,821



180 Dorpel Profielen

Product Code	3207
Gewicht (kg/mt)	0,940



195 Dorpel Profielen

Product Code	3208
Gewicht (kg/mt)	0,997



210 Dorpel Profielen

Product Code	3209
Gewicht (kg/mt)	1,127

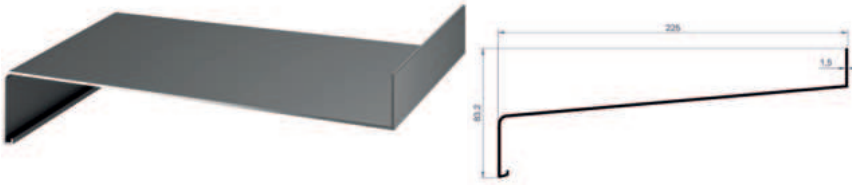

225 Dorpel Profielen

Product Code	3210
Gewicht (kg/mt)	1,187

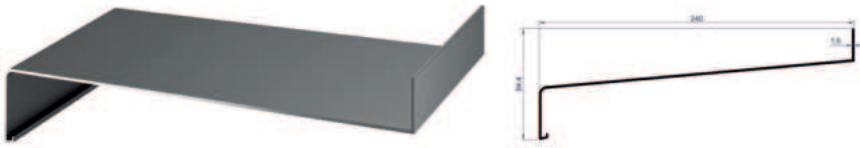

240 Dorpel Profielen



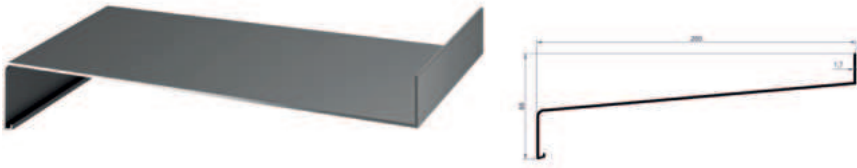









Product Code	3211
Gewicht (kg/mt)	1,327



260 Dorpel Profielen

Product Code	3212
Gewicht (kg/mt)	1,501



Dorpel Profielen			
Afbeelding.	Profielnr.	Profiel Beschrijving	Kg / mt
	3200	50 Dorpel Profielen	0,328
	3201	70 Dorpel Profielen	0,382
	3202	90 Dorpel Profielen	0,477
	3203	110 Dorpel Profielen	0,537
	3204	130 Dorpel Profielen	0,648
	3205	150 Dorpel Profielen	0,740
	3206	165 Dorpel Profielen	0,821
	3207	180 Dorpel Profielen	0,940
	3208	195 Dorpel Profielen	0,997
	3209	210 Dorpel Profielen	1,127
	3210	225 Dorpel Profielen	1,187
	3211	240 Dorpel Profielen	1,327
	3212	260 Dorpel Profielen	1,501

LEUNING SERIE



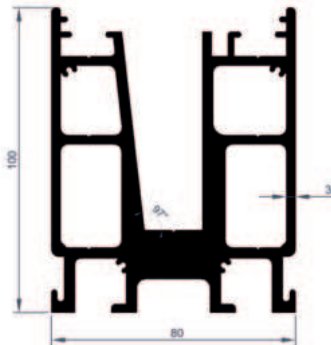

Klos Bodemprofiel

Product Code	4023
Gewicht (kg/mt)	6,545

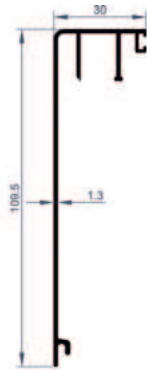

Wigbodem Afdekprofiel

Product Code	4024
Gewicht (kg/mt)	0,648

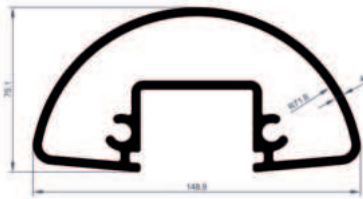

Wig Bovenste Sokkel Profiel

Product Code	4025
Gewicht (kg/mt)	0,824

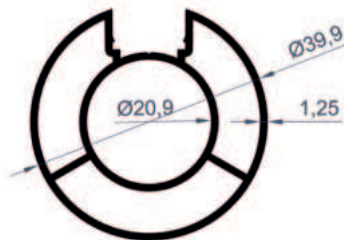

40 Stutprofiel

Product Code	4100
Gewicht (kg/mt)	0,705



Afdekprofiel

Product Code	4101
Gewicht (kg/mt)	0,065

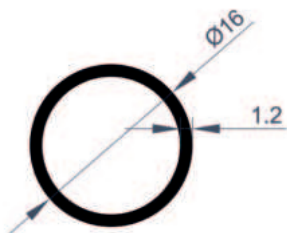

16 Pijp Profiel

Product Code	4102
Gewicht (kg/mt)	0,152

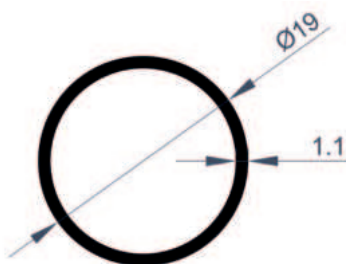

19 Pijp Profiel

Product Code	4103
Gewicht (kg/mt)	0,168

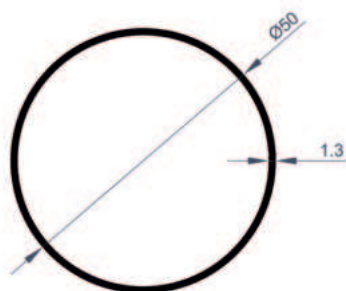

50 Pijp Profiel

Product Code	4104
Gewicht (kg/mt)	0,537

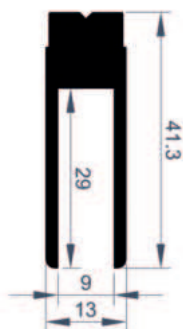

Glazen Houder Profiel

Product Code	4105
Gewicht (kg/mt)	0,726

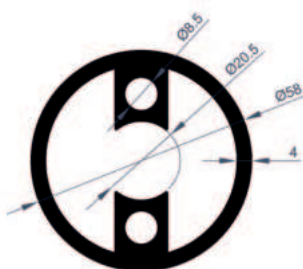

Aansluitprofiel

Product Code	4106
Gewicht (kg/mt)	2,688

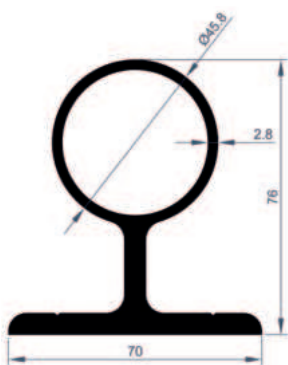

Aansluitprofiel

Product Code	4107
Gewicht (kg/mt)	2,572

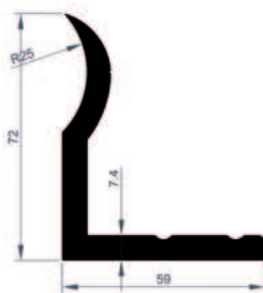
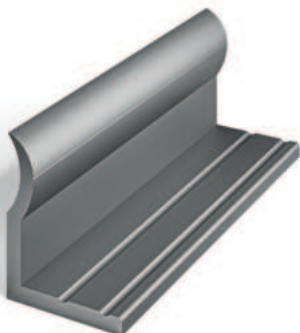

Draagprofiel L

Product Code	4108
Gewicht (kg/mt)	2,374

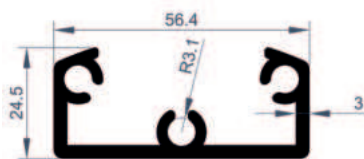

Aansluitprofiel

Product Code	4109
Gewicht (kg/mt)	1,089

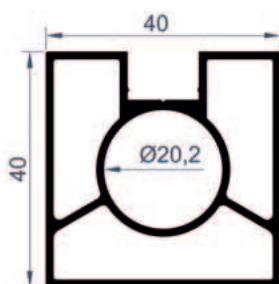
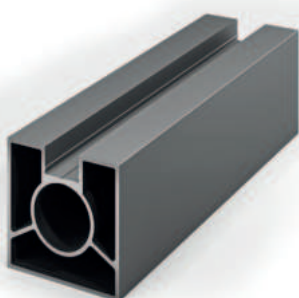

Vierkant Profiel 40X40

Product Code	4110
Gewicht (kg/mt)	0,916

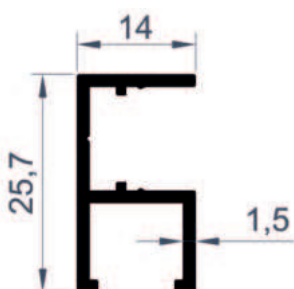

F Profiel

Product Code	4111
Gewicht (kg/mt)	0,263

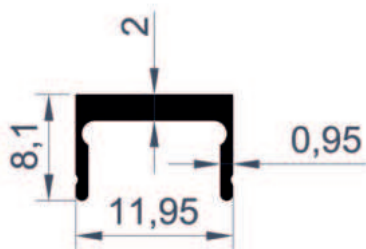
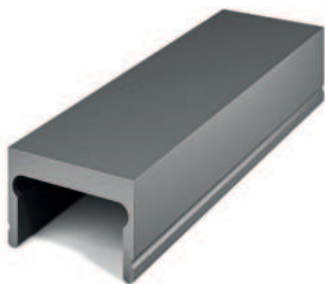

Afdekprofiel

Product Code	4112
Gewicht (kg/mt)	0,092

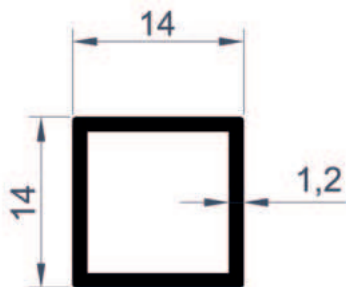

14x14 Doos Profiel

Product Code	4113
Gewicht (kg/mt)	0,165

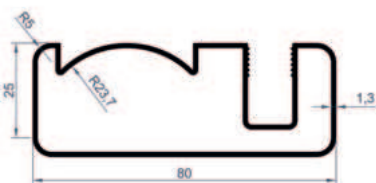
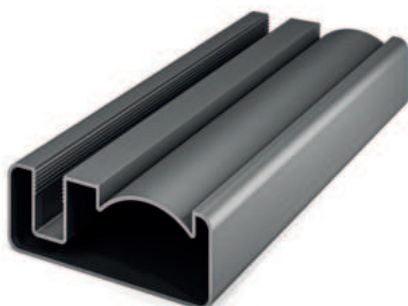

80 Bovenste Sokkelprofiel

Product Code	4114
Gewicht (kg/mt)	0,949

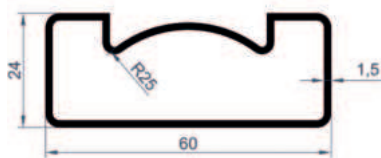
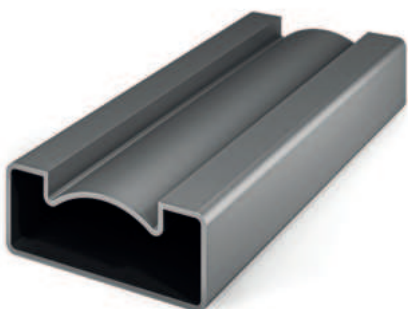

60 Bovenste Sokkelprofiel

Product Code	4115
Gewicht (kg/mt)	0,705

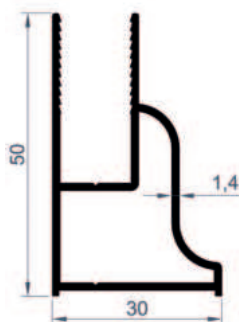
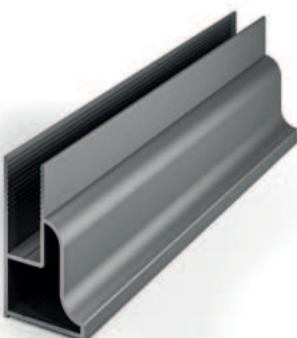

Klos Bodemprofiel



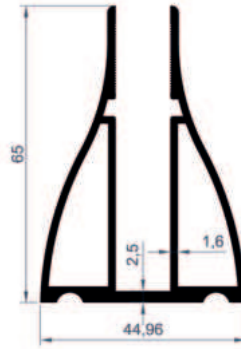





Product Code	4116
Gewicht (kg/mt)	0,607







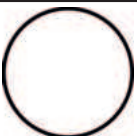





Klos Bodemprofil

Product Code	4117
Gewicht (kg/mt)	1,282

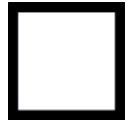

Profielen Leuning Serie			
Afbeelding.	Profielnr.	Profiel Beschrijving	Kg / mt
	4023	Klos Bodemprofiel	6,545
	4024	Wigbodem Afdekprofiel	0,648
	4025	Wig Bovenste Sokkel Profiel	0,824
	4100	40 Stutprofiel	0,705
	4101	Afdekprofiel	0,065
	4102	16 Pijp Profiel	0,152
	4103	19 Pijp Profiel	0,168
	4104	50 Pijp Profiel	0,537
	4105	Glazen Houder Profiel	0,726
	4106	Aansluitprofiel	2,688

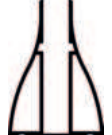

Afbeelding.	Profielnr.	Profiel Beschrijving	Kg / mt
	4107	Aansluitprofiel	2,572
	4108	Draagprofiel L	2,374
	4109	Aansluitprofiel	1,089
	4110	Vierkant Profiel 40X40	0,916
	4111	F Profiel	0,263
	4112	Afdekprofiel	0,092
	4113	14x14 Doos Profiel	0,165
	4114	80 Bovenste Sokkelprofiel	0,949
	4115	60 Bovenste Sokkelprofiel	0,705
	4116	Klos Bodemprofiel	0,607
	4117	Klos Bodemprofiel	1,282

GLAZEN BALKON SERIE

 BEPRO

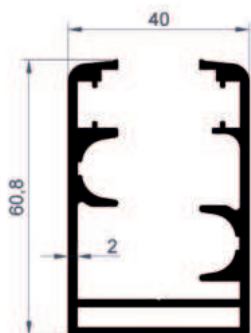

Railprofiel

Product Code	4118
Gewicht (kg/mt)	1,425

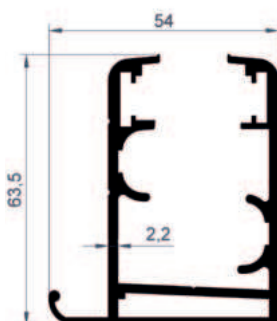

Railprofiel

Product Code	4119
Gewicht (kg/mt)	1,575

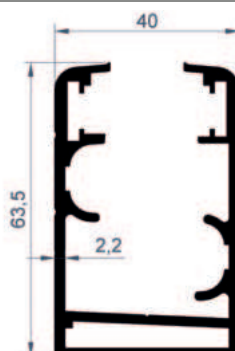

Railprofiel

Product Code	4120
Gewicht (kg/mt)	1,496

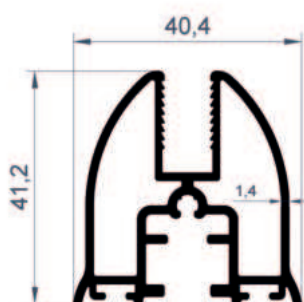

Paneel Boven- En Onderprofiel

Product Code	4121
Gewicht (kg/mt)	0,916

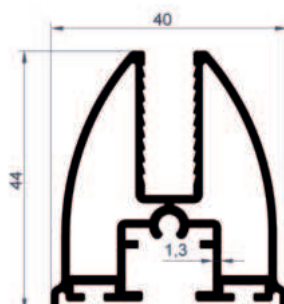

Paneel Boven- En Onderprofiel

Product Code	4122
Gewicht (kg/mt)	0,883

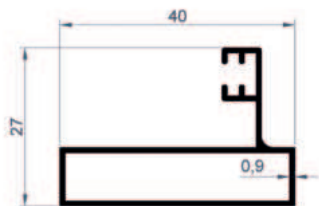

Smal Zijframe Stutprofiel

Product Code	4123
Gewicht (kg/mt)	0,325

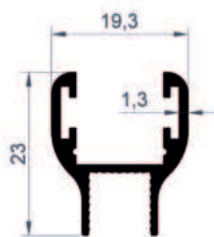

(H) Latprofiel



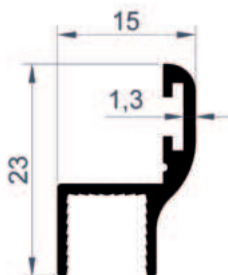





Product Code	4124
Gewicht (kg/mt)	0,257



(L) Latprofiel

Product Code	4125
Gewicht (kg/mt)	0,168



Glazen Balkon Serie Profielen			
Afbeelding.	Profielnr.	Profiel Beschrijving	Kg / mt
	4118	Railprofiel	1,425
	4119	Railprofiel	1,575
	4120	Railprofiel	1,496
	4121	Paneel Boven- En Onderprofiel	0,916
	4122	Paneel Boven- En Onderprofiel	0,883
	4123	Smal Zijframe Stutprofiel	0,325
	4124	(H) Latprofiel	0,257
	4125	(L) Latprofiel	0,168

PERGOLA SERIE

 **BEPRO**

103

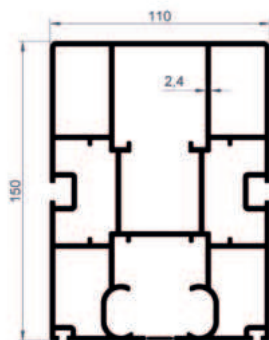

Railprofil

Product Code	4126
Gewicht (kg/mt)	7,032

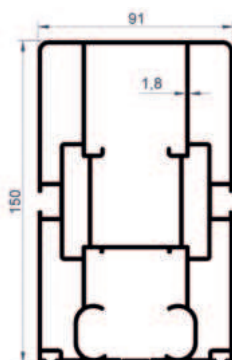

Railprofil

Product Code	4127
Gewicht (kg/mt)	4,973

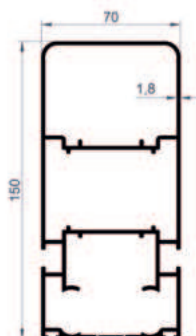

Railprofil

Product Code	4128
Gewicht (kg/mt)	3,222

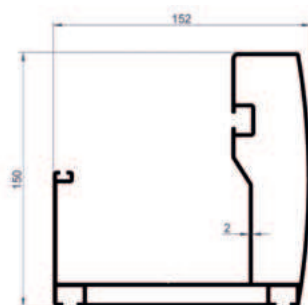

Gootprofil

Product Code	4129
Gewicht (kg/mt)	4,095

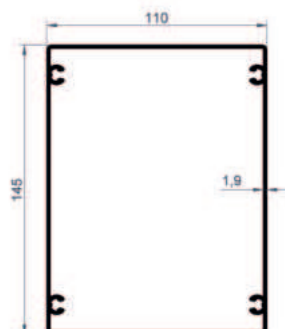

Stutprofil

Product Code	4130
Gewicht (kg/mt)	2,875

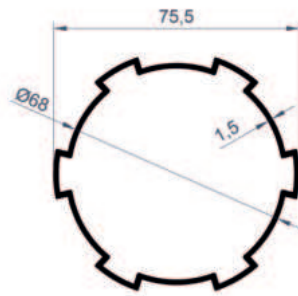
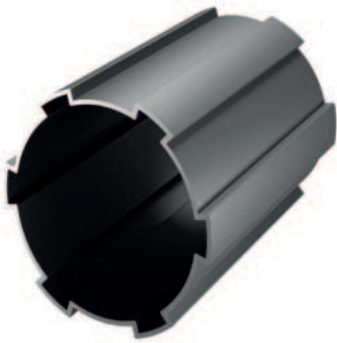

Motorbuis Profiel

Product Code	4131
Gewicht (kg/mt)	1,100



Profiel Trapeziumvormige Doos

Product Code	4132
Gewicht (kg/mt)	1,518

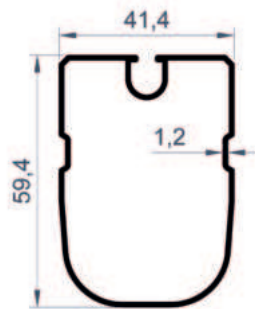

Doekprofiel



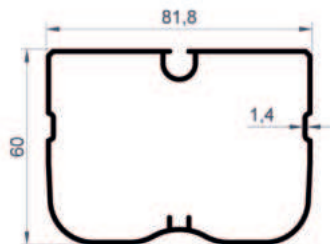



Product Code	4133
Gewicht (kg/mt)	0,664

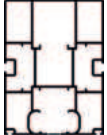
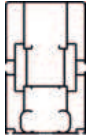

Doekprofiel

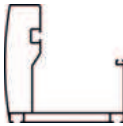
Product Code	4134
Gewicht (kg/mt)	1,108

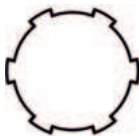

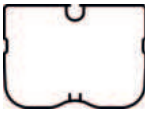
Pergola Serie Profielen			
Afbeelding.	Profielnr.	Profiel Beschrijving	Kg / mt
	4126	Railprofiel	7,032
	4127	Railprofiel	4,973
	4128	Railprofiel	3,222
	4129	Gootprofiel	4,095
	4130	Stutprofiel	2,875
	4131	Motorbuis Profiel	1,100
	4132	Profiel Trapeziumvormige Doos	1,518
	4133	Doekprofiel	0,664
	4134	Doekprofiel	1,108

ACCORDEON DEUR SERIE

 **BEPRO**

107





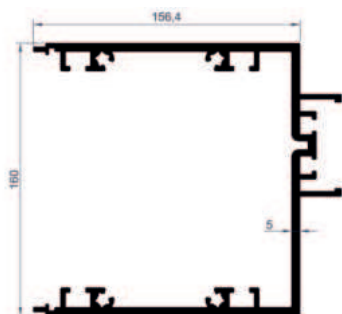

Stutprofiel

Product Code	4202
Gewicht (kg/mt)	8,501

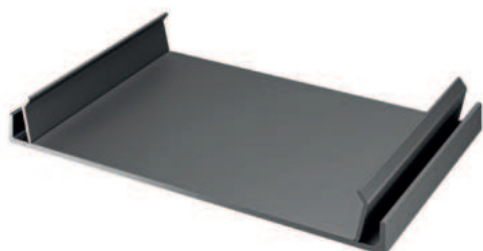

Stut Afdekprofiel

Product Code	4203
Gewicht (kg/mt)	1,106

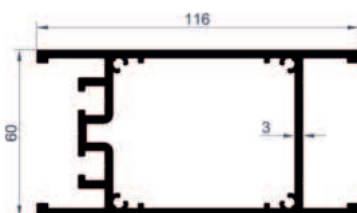
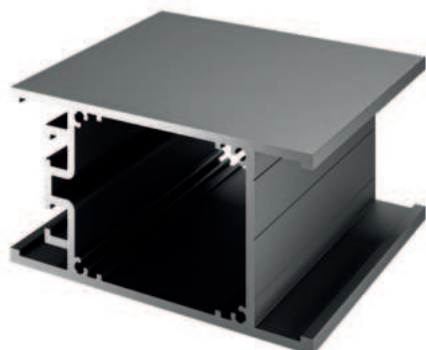

Frame Vleugelprofiel

Product Code	4204
Gewicht (kg/mt)	3,347

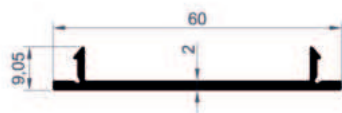
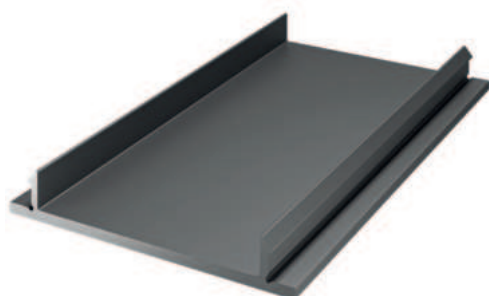

Vleugel Afdekprofiel

Product Code	4205
Gewicht (kg/mt)	0,379

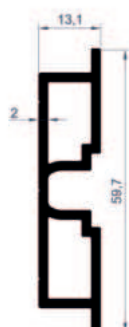

Vleugelbinnenprofiel

Product Code	4206
Gewicht (kg/mt)	0,748

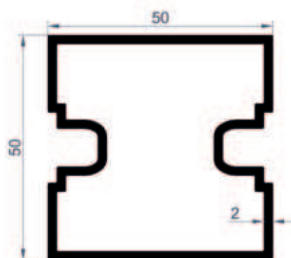

50x30 Doos Profiel

Product Code	4207
Gewicht (kg/mt)	1,252

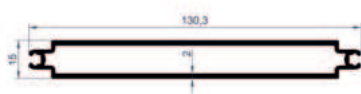
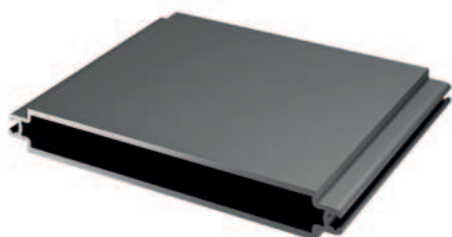

Lambiri Profiel

Product Code	4208
Gewicht (kg/mt)	1,466

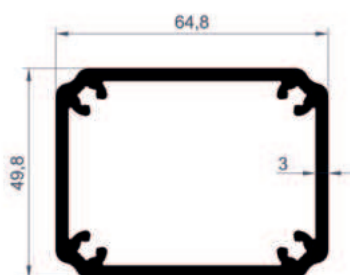
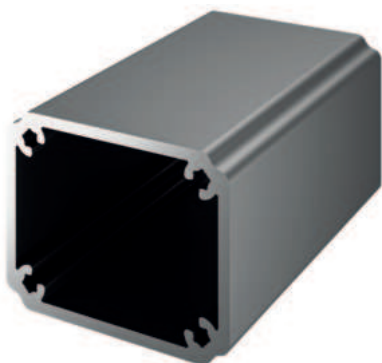

Kast Intern Verankeringsprofiel

Product Code	4209
Gewicht (kg/mt)	1,984

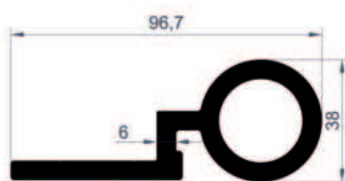

Scharnier Profiel



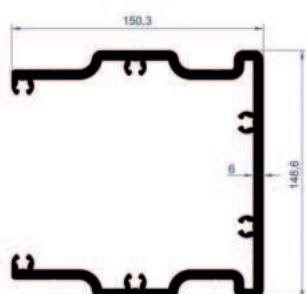





Product Code	4210
Gewicht (kg/mt)	2,889

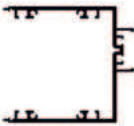

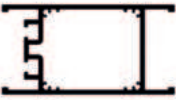
Stut Binnenverankeringsprofiel

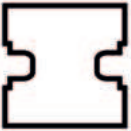
Product Code	4211
Gewicht (kg/mt)	8,642

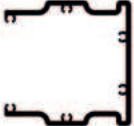

Accordeon Deur Serie Profielen			
Afbeelding.	Profielnr.	Profiel Beschrijving	Kg / mt
	4202	Stutprofiel	8,501
	4203	Stut Afdekprofiel	1,106
	4204	Frame Vleugelprofiel	3,347
	4205	Vleugel Afdekprofiel	0,379
	4206	Vleugelbinnenprofiel	0,748
	4207	50x30 Doos Profiel	1,252
	4208	Lambiri Profiel	1,466
	4209	Kast Intern Verankeringsprofiel	1,984
	4210	Scharnier Profiel	2,889
	4211	Stut Binnenverankeringsprofiel	8,642



Certification is conditional on maintaining the required performance standards throughout the certified period of registration
Amtivo Group Limited, 30 Tower View, Kings Hill, Kent, ME19 4UY

The management system of Certificate Number **626352**
GNS PROFIL ALUMINYUM A.S.
ATAKOY 7-8-9-10 KISIM MAH., NILIFER SOK. NO:4 DB A5 B BLOK D:98, BAKIRKOY/ISTANBUL
has been assessed and certified as meeting the requirements of

ISO 9001:2015

ALUMINUM PROFILE PRODUCTION (SURFACE TREATMENT, ALUMINUM EXTRUSION MOULD DESIGN AND PRODUCTION) FOR VARIOUS SECTORS BOTH DOMESTIC AND WORLDWIDE

Further clarifications regarding the scope of this certificate and the applicability of requirements may be obtained by consulting the certifier.

Valid from
Initial Certification: 11 January 2024
Latest Issue: 11 January 2024
Expiry Date: 10 January 2025
Recertification Before: 10 January 2027
subject to annual assessments

Authorised by

Mike Tims
Chief Executive Officer

Expiry Date: **10 January 2025**

Certificate Number **626352**

Locations Covered



8289

- GNS PROFIL ALUMINYUM A.S.
ATAKOY 7-8-9-10 KISIM MAH., NILIFER SOK. NO:4 DB A5 B BLOK D:98, BAKIRKOY/ISTANBUL
- GNS PROFIL ALUMINYUM A.S.
KARAAGAC OSB MAH., KAPAKLI OSB 104.CAD. NO:15/1, KAPAKLI/ TEKIRDAG, TURKIYE

www.amtivo.com

Certificate issued by Amtivo Group Limited



The validity and status of this certificate can be verified by using the UKAS CertCheck website at certcheck.ukas.com

CERTIFICATE

of Conformity of the Factory Production Control

1922 - CPR - 2181

In compliance with Regulation (EU) No 305/2011 of the European Parliament and of the council of 9 March 2011 (the Construction Products Regulation or CPR), this certificate applies to the construction product

ALUMINIUM AND ALUMINIUM ALLOYS. STRUCTURAL PRODUCTS FOR CONSTRUCTION WORKS. HOT EXTRUDED PROFILES

for load-bearing structural construction works

Alloys: EN AW-6060, EN AW-6063

placed on the market under the name or trade mark of

GNS PROFİL ALÜMİNYUM ANONİM ŞİRKETİ

ATAKÖY 7-8-9-10. KISIM MAH. NİLÜFER SK. A5 BLOK NO: 4 DB İÇ KAPI NO: 98

BAKIRKÖY/ ISTANBUL/TÜRKİYE

and produced in the manufacturing plant

GNS PROFİL ALÜMİNYUM ANONİM ŞİRKETİ

**KARAAĞAÇ OSB MAH. KAPAKLI OSB 104. CAD.NO:15/1 KAPAKLI/TEKİRDAĞ/
TÜRKİYE**

This certificate attests that all provisions concerning the assessment and verification of constancy of performance described in Annex ZA of the standard

EN 15088:2005

under system 2+ are applied and that the factory production control is assessed to be in conformity with the applicable requirements.

This certificate was first issued on 24.04.2024 and will remain valid until 24.04.2025 as long as neither the harmonised standard, the construction product, the AVCP methods nor the manufacturing conditions in the plant are modified significantly, unless suspended or withdrawn by the notified factory production control certification body. The certificate is supported through annual surveillance audit and is reissued after each surveillance audit. The validity of the certificate may be confirmed in the CE register at the web address www.dedal-bg.net.



Manager:

Anna Vasileva



dipl. eng. Anna Vasileva

Issued:
Burgas, 24 April 2024

Ref. No. 01-00

SERTİFİKA

GNS PROFİL ALUMİNYUM A.Ş.

ATAKÖY 7-8-9-10 KISIM MAH. NİLİFER SOK. NO:4 DB A5 B BLOK D:98 BAKIRKÖY/İSTANBUL
KARAAĞAÇ OSB MAH. KAPAKLI OSB 104.CAD. NO:15/1 KAPAKLI/ TEKİRDAĞ

SRS BELGELENDİRME yukarıda adı geçen kuruluşun Müşteri Memnuniyeti ve Şikayet Yönetim Sisteminin aşağıdaki kapsamda denetlendiğini ve standardın gereklerine uygun olduğunu belgelemektedir.

ISO 10002 : 2018

Yurt İçi Ve Yurt Dışı Çeşitli Sektörler İçin Alüminyum Profil Üretimi (Yüzey İşlem, Alüminyum Ekstrüzyon Kalıp Tasarım Ve Üretimi)

Sertifika Başlangıç Tarihi : 15 Ocak 2024
Sertifika Düzenleme Tarihi : 15 Ocak 2024
Sertifika Geçerlilik Tarihi : 14 Ocak 2025
Belgelendirme Periyodu : 3 Yıl
Sertifika No : SRS/EN/10002/15012024-1

Yetkili Onayı:

BÜLENT YILMAZ

Bu belge, adı geçen kuruluşun yönetim sistemlerini yukarıda belirtilen ve her yıl SRS BELGELENDİRME tarafından denetlenecek standart ve yönergelere uygun olarak sürdürdüğü sürece geçerliliğini korur. Bu belgenin mülkiyet hakkı SRS BELGELENDİRME'ye aittir ve makul talep üzerine SRS BELGELENDİRME'ye iade edilmelidir.

SRS ULUSLARARASI BELGELENDİRME TEKNİK KONTROL GÖZETİM ve EĞİTİM HİZMETLERİ LTD. ŞTİ.
Barış Mah. Akdeniz Cad. No:8/1 İç Kapı No:58 Beylikdüzü / İSTANBUL
Tel: +90 212 854 15 10 | www.srscert.com | info@srscert.com



BEPRO

www.bepro.com.tr