



CATALOGO PRODOTTI PROFILI IN ALLUMINIO



BEPRO



CHI SIAMO?

Per rispondere alle esigenze del settore con i suoi 40 anni di esperienza e conoscenza del settore, GNS Group of Companies ha iniziato a offrire soluzioni professionali in alluminio fondando GNS Profil Alüminyum A.Ş. che opera nel campo dei profili in alluminio nel 2022. Continuando a investire per diventare un marchio internazionale, il nostro gruppo di aziende ha fondato GNS Europe B.V. nel 2023 e ha creato il marchio "BEPRO" nel 2024.

I nostri impianti integrati, situati nei quartieri Ergene e Kapaklı di Tekirdağ, offrono soluzioni innovative su una superficie totale di 35.000 m², di cui 29.000 m² chiusi, con macchinari di tecnologia avanzata e un team professionale di 150 persone.

La nostra fabbrica di profili produce profili con le nostre linee di estrusione da 5-7-9 pollici.

La Nostra Missione

Offrire ai nostri clienti la giusta combinazione di qualità e prezzo e fornire loro il miglior servizio come fornitore di profili preferito.

La Nostra Visione

Contribuire in modo sostenibile all'occupazione e alla produzione del nostro Paese in collaborazione con i nostri clienti.

Lasciare un mondo pulito e vivibile alle generazioni future utilizzando la nostra alta tecnologia di produzione.

Essere un pioniere nel proprio settore e un marchio di valore nel mercato internazionale.



Telefono

+90 850 380 01 59

Posta

info@bepro.com.tr
info@gnsprofil.com
bepro.com.tr
gnsprofil.com

Indirizzo della Sede Centrale

Ataköy
7-8-9-10. Kısım Mahallesi
Nilüfer Sk, A5 Blok, No:4DB 34140
Bakırköy Istanbul



Personale Professionale

Forniamo i nostri servizi in modo professionale con i nostri team di esperti e le nostre attrezzature ad alta tecnologia, in possesso di capacità avanzate.



Il Nostro Valore

Onestà e integrità sono i nostri valori prioritari, sempre e in ogni condizione.

Indirizzo della Fabbrica 1

GNS PROFIL
Kapaklı OSB 104. Cad. No.
No:15/1
Kapaklı / Tekirdağ

Indirizzo della Fabbrica 2

GNS PROFIL
Velimeşe OSB Mah. 227 Sk.
No: 15/1
Ergene / Tekirdağ



Qualità

Diamo priorità alla soddisfazione dei nostri clienti al massimo livello e ci sforziamo di produrre servizi e soluzioni che soddisfino le loro aspettative con un alto livello di qualità.



Consegna Puntuale

Rispettiamo gli impegni presi con successo entro i tempi promessi.

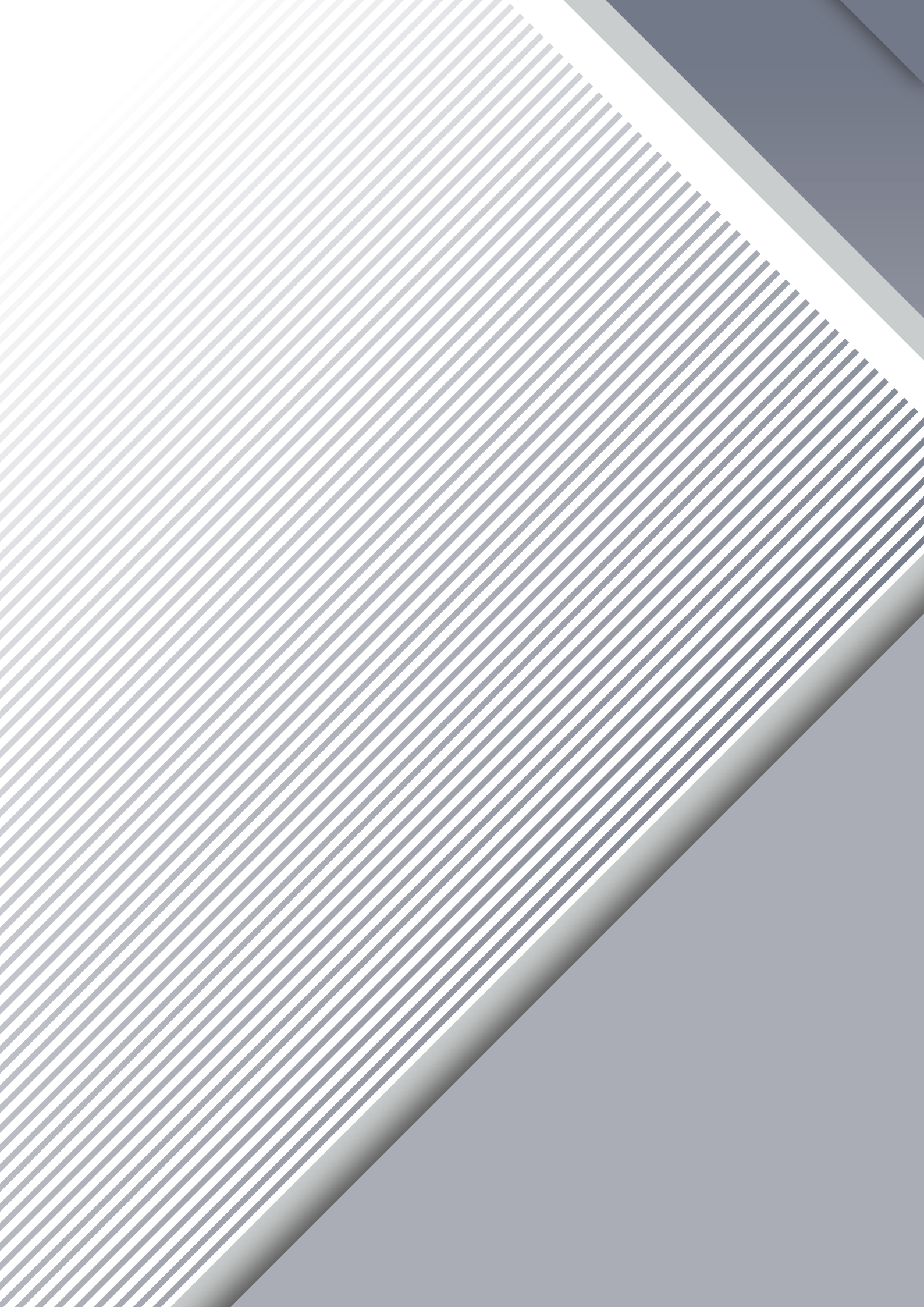

CONTENUTO

09

Profili Della Serie Veranda

17

Profili Della Serie BQB Veranda

25

Profili Della Serie Scorrevole Standard

33

Profili Della Serie Scorrevole Diamond

40

Profili Standard

47

Profili Della Serie Garden Fence

55

Profili Motorizzati Della Serie Bioclimatic

63

Profili Manuali Della Serie Bioclimatic

69

Profili Delle Serie Di Tende Da Soffitto

73

Profili Serie C60

79

Profili Serie Aldoks

86

Profili Dei Davanzali

91

Profili Della Serie Corrimano

99

Profili Per Balconi In Vetro

103

Profili Della Serie Pergola

107

Profili Per Porte a Fisarmonica



SERIE VERANDA

 BEPRO





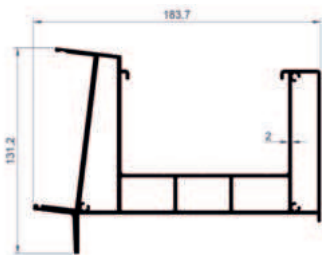

Profilo della Grondaia

Codice Prodotto	2001
Peso (kg/mt)	5,274



Profilo di Grondaia Dritto

Codice Prodotto	2002
Peso (kg/mt)	1,249

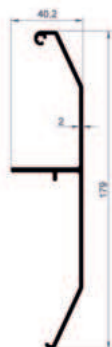

Profilo a 3 Scanalature Pieghevoli

Codice Prodotto	2003
Peso (kg/mt)	1,415



Profilo a Parete

Codice Prodotto	2004
Peso (kg/mt)	2,201

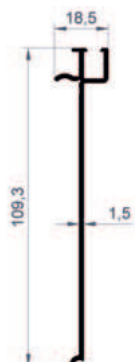

Profilo Interno a Parete e Grondaia

Codice Prodotto	2005
Peso (kg/mt)	0,580

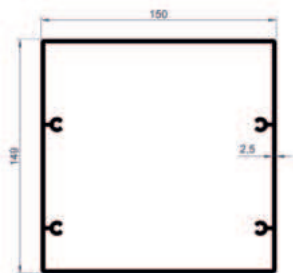

Profilo a Montante

Codice Prodotto	2006
Peso (kg/mt)	4,482

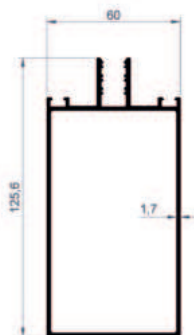

Profilo Portavetro Centrale

Codice Prodotto	2007
Peso (kg/mt)	1,916

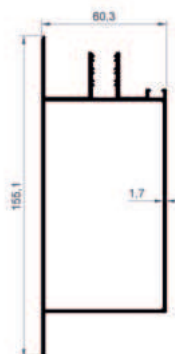

Profilo Portante del Bordo

Codice Prodotto	2008
Peso (kg/mt)	2,016

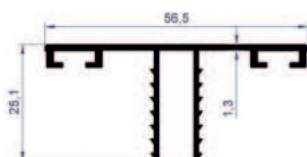

Profilo di Copertura a Compressione del Supporto

Codice Prodotto	2009
Peso (kg/mt)	0,436

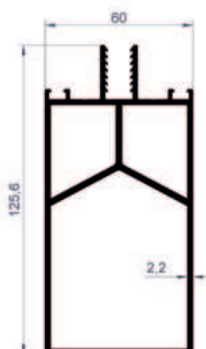

Profilo Portante In Vetro Supportato

Codice Prodotto	2010
Peso (kg/mt)	2,837

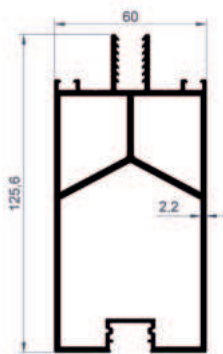

Profilo Portante In Vetro Integrato a Led

Codice Prodotto	2011
Peso (kg/mt)	2,913

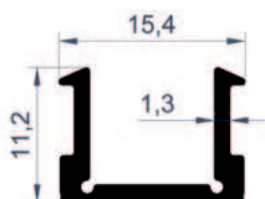

Profilo di Copertura del Vetro Integrato a Led

Codice Prodotto	2012
Peso (kg/mt)	0,144

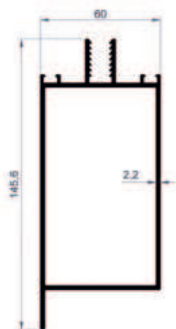

Profilo di Supporto del Bordo

Codice Prodotto	2013
Peso (kg/mt)	2,369

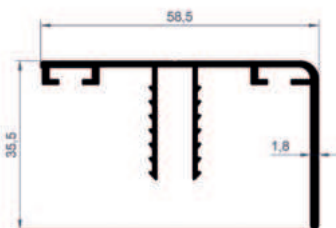

Profilo di Copertura a Compressione Laterale del Supporto

Codice Prodotto	2014
Peso (kg/mt)	0,591



Profilo di Grondaia Semi-Ovale

Codice Prodotto	2015
Peso (kg/mt)	1,542

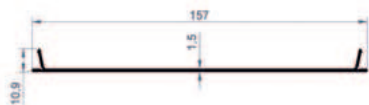
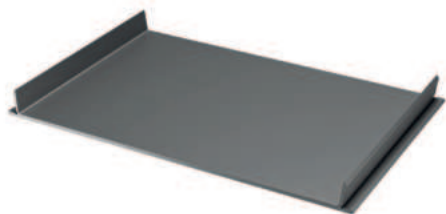

Profilo di Supporto Centrale Profilo di Copertura

Codice Prodotto 2048

Peso (kg/mt) 0,696

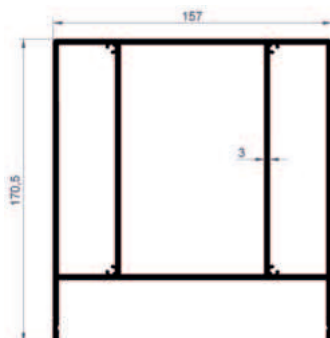









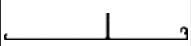
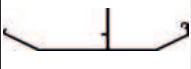
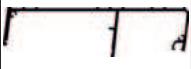



Profilo di Supporto Medio

Codice Prodotto 2049

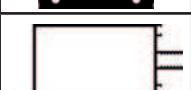
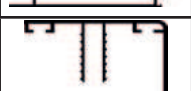
Peso (kg/mt) 7,420



Profili Della Serie Veranda			
Immagine.	Profilo N.	Descrizione Del Profilo	Kg / mt
	2001	Profilo della Grondaia	5,274
	2002	Profilo di Grondaia Dritto	1,249
	2003	Profilo a 3 Scanalature Pieghevoli	1,415
	2004	Profilo a Parete	2,201
	2005	Profilo Interno a Parete e Grondaia	0,580
	2006	Profilo a Montante	4,482
	2007	Profilo Portavetro Centrale	1,916
	2008	Profilo Portante del Bordo	2,016
	2009	Profilo di Copertura a Compressione del Supporto	0,436
	2010	Profilo Portante In Vetro Supportato	2,837
	2011	Profilo Portante In Vetro Integrato a Led	2,913
	2012	Profilo di Copertura del Vetro Integrato a Led	0,144
	2013	Profilo di Supporto del Bordo	2,369
	2014	Profilo di Copertura a Compressione Laterale del Supporto	0,591
	2015	Profilo di Grondaia Semi-Ovale	1,542
	2048	Profilo di Supporto Centrale Profilo di Copertura	0,696
	2049	Profilo di Supporto Medio	7,420

SERIE BQB VERANDA

 **BEPRO**





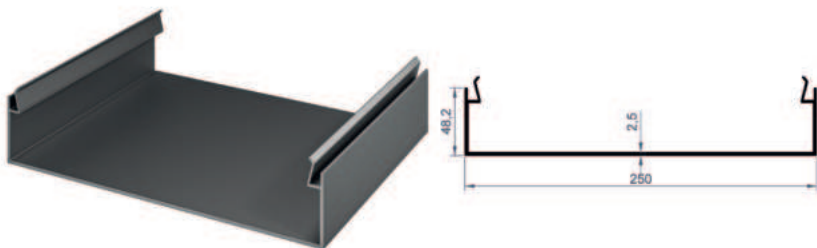

Profilo di Copertura a Puntone

Codice Prodotto	2020
Peso (kg/mt)	2,528

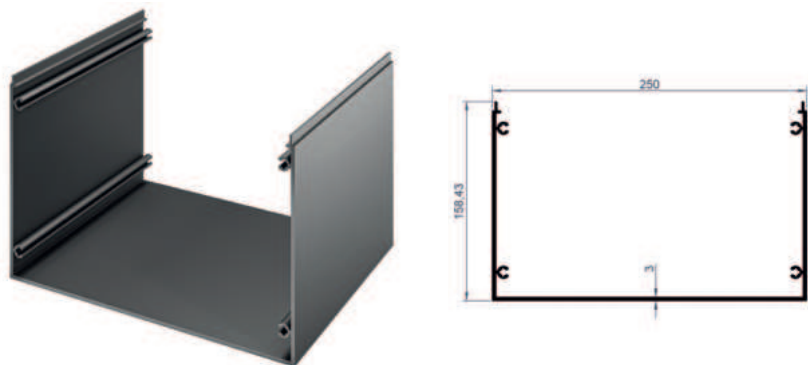

Profilo a Montante

Codice Prodotto	2021
Peso (kg/mt)	5,030



Profilo del Giunto del Montante della Grondaia

Codice Prodotto	2022
Peso (kg/mt)	2,913

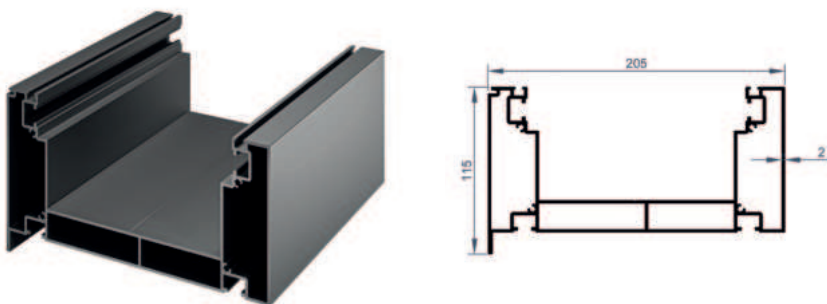

Profilo della Grondaia

Codice Prodotto	2023
Peso (kg/mt)	5,168

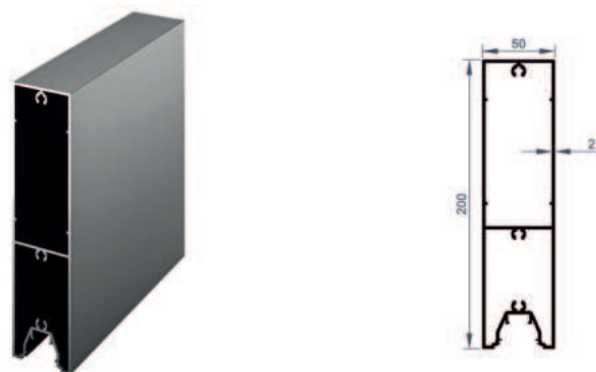

Profilo del Montante Portante In Vetro

Codice Prodotto	2024
Peso (kg/mt)	3,501

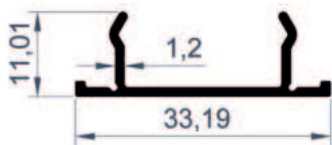
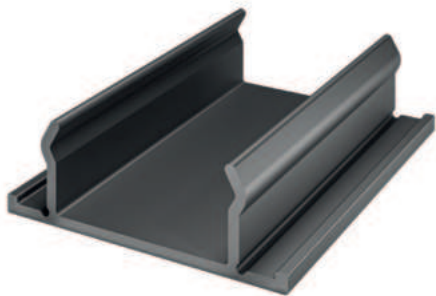

Profilo del Montante Portante In Vetro

Codice Prodotto	2025
Peso (kg/mt)	0,176



Copertura del Profilo a Parete

Codice Prodotto	2026
Peso (kg/mt)	1,016

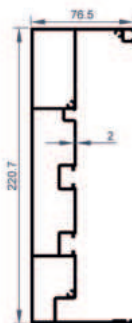

Profilo a Parete

Codice Prodotto	2027
Peso (kg/mt)	4,179

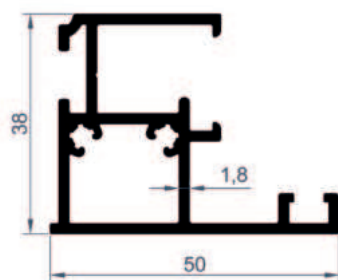

Profilo del Giunto del Montante Portante In Vetro

Codice Prodotto	2028
Peso (kg/mt)	0,848

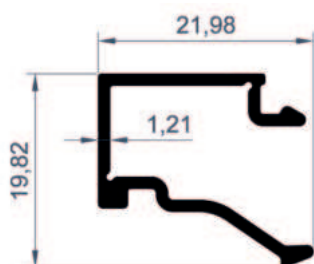
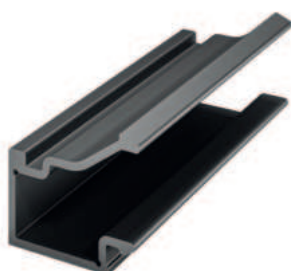

Profilo del Giunto del Montante Portante In Vetro

Codice Prodotto	2029
Peso (kg/mt)	0,203

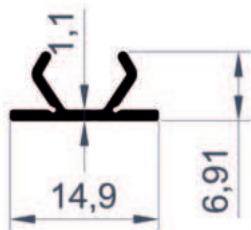

Profilo Copertura Grondaia e Montante



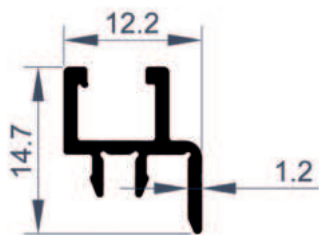
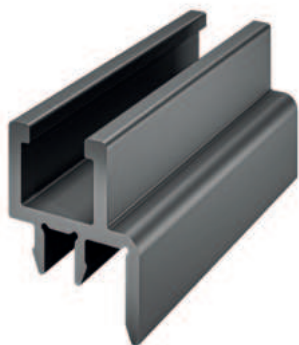





Codice Prodotto	2030
Peso (kg/mt)	0,079

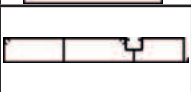
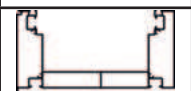
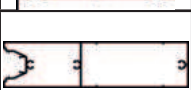

Profilo di Copertura Grondaia e Parete Stoppino

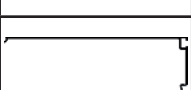
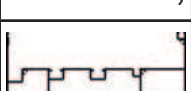
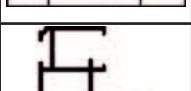
Codice Prodotto	2031
Peso (kg/mt)	0,117



Profili Della Serie BQB Veranda			
Immagine.	Profilo N.	Descrizione Del Profilo	Kg / mt
	2020	Profilo di Copertura a Puntone	2,528
	2021	Profilo a Montante	5,030
	2022	Profilo del Giunto del Montante della Grondaia	2,913
	2023	Profilo della Grondaia	5,168
	2024	Profilo del Montante Portante In Vetro	3,501
	2025	Profilo del Montante Portante In Vetro	0,176
	2026	Copertura del Profilo a Parete	1,016
	2027	Profilo a Parete	4,179
	2028	Profilo del Giunto del Montante Portante In Vetro	0,848
	2029	Profilo del Giunto del Montante Portante In Vetro	0,203
	2030	Profilo Copertura Grondaia e Montante	0,079
	2031	Profilo di Copertura Grondaia e Parete Stop-pino	0,117



SERIE SCORREVOLE STANDARD



BEPRO





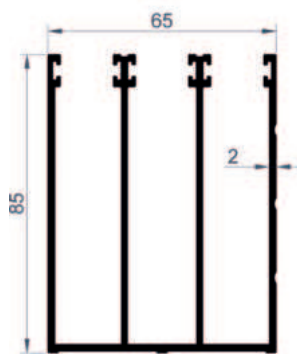

3-Profilo della Rotaia

Codice Prodotto	2300
Peso (kg/mt)	2,209

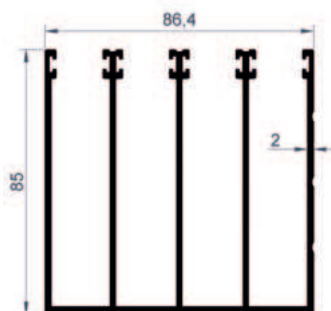

4-Profilo della Rotaia

Codice Prodotto	2301
Peso (kg/mt)	2,789

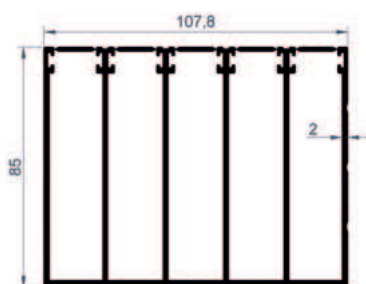
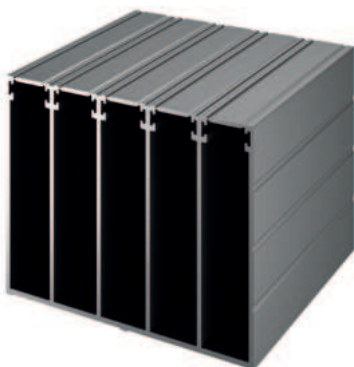

5-Profilo della Rotaia

Codice Prodotto	2302
Peso (kg/mt)	3,661

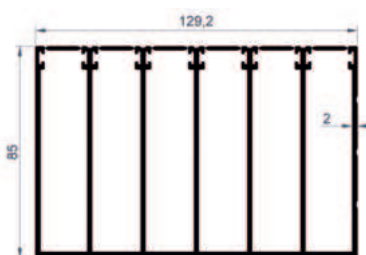
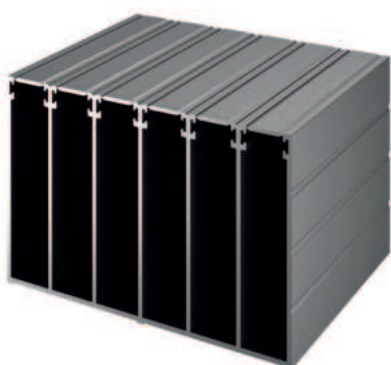

6-Profilo della Rotaia

Codice Prodotto	2303
Peso (kg/mt)	4,298

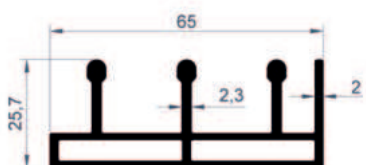
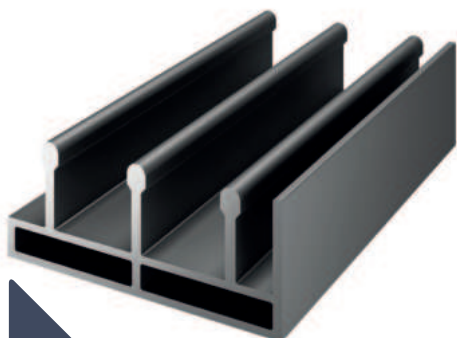

Profilo Inferiore a 3 Guide

Codice Prodotto	2304
Peso (kg/mt)	1,138

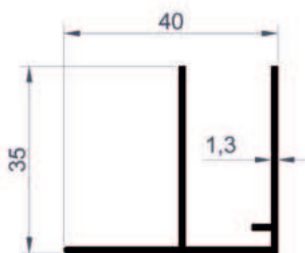

(F) Profilo

Codice Prodotto	2305
Peso (kg/mt)	0,377

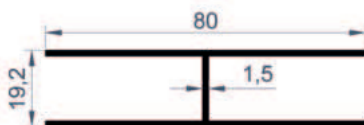
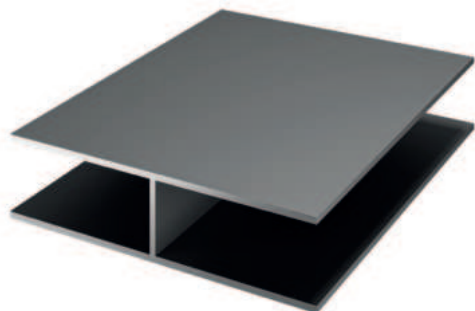

(H) Profilo

Codice Prodotto	2306
Peso (kg/mt)	0,715

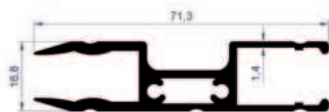

Profilo del Piedistallo Inferiore

Codice Prodotto	2307
Peso (kg/mt)	0,916

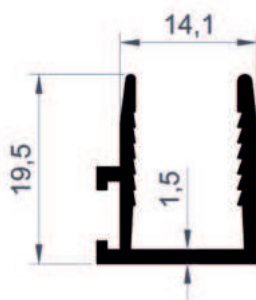

Profilo della Modanatura Laterale

Codice Prodotto	2308
Peso (kg/mt)	0,222

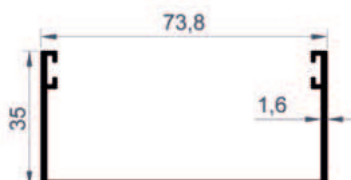

Profilo a 3 Binari del Montante Laterale

Codice Prodotto	2309
Peso (kg/mt)	0,661

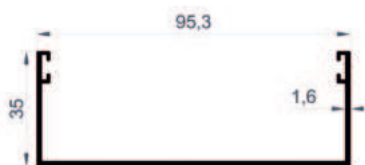

Profilo a 4 Binari del Montante Laterale

Codice Prodotto	2310
Peso (kg/mt)	0,756

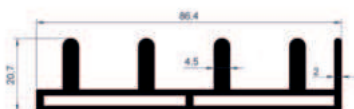

Profilo Inferiore a 4 Binari

Codice Prodotto	2311
Peso (kg/mt)	1,558

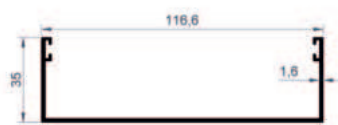

Profilo a 5 Binari del Montante Laterale

Codice Prodotto	2312
Peso (kg/mt)	0,848

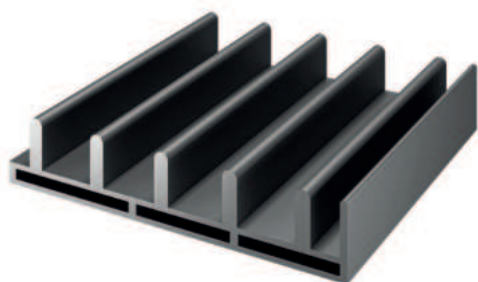

Profilo Inferiore a 5 Binari

Codice Prodotto	2313
Peso (kg/mt)	1,943



Puntone Laterale Profilo a 6 Binari

Codice Prodotto	2314
Peso (kg/mt)	0,864

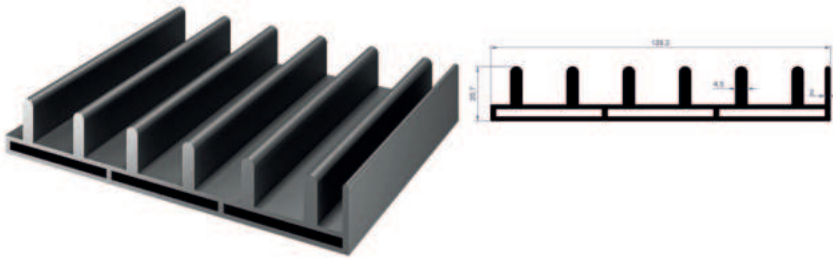

Profilo Inferiore a 6 Binari

Codice Prodotto	2315
Peso (kg/mt)	2,287



Profilo Lambiri

Codice Prodotto	2316
Peso (kg/mt)	1,382



Profilo di Kulp

Codice Prodotto	2317
Peso (kg/mt)	1,019



Profilo di Kulp

Codice Prodotto	2318
Peso (kg/mt)	1,111



Profili Della Serie Scorrevole Standard			
Immagine.	Profilo N.	Descrizione Del Profilo	Kg / mt
	2300	3-Profilo della Rotaia	2,209
	2301	4-Profilo della Rotaia	2,789
	2302	5-Profilo della Rotaia	3,661
	2303	6-Profilo della Rotaia	4,298
	2304	Profilo Inferiore a 3 Guide	1,138
	2305	(F) Profilo	0,377
	2306	(H) Profilo	0,715
	2307	Profilo del Piedistallo Inferiore	0,916
	2308	Profilo della Modanatura Laterale	0,222
	2309	Profilo a 3 Binari del Montante Laterale	0,661
	2310	Profilo a 4 Binari del Montante Laterale	0,756
	2311	Profilo Inferiore a 4 Binari	1,558
	2312	Profilo a 5 Binari del Montante Laterale	0,848
	2313	Profilo Inferiore a 5 Binari	1,943
	2314	Puntone Laterale Profilo a 6 Binari	0,864
	2315	Profilo Inferiore a 6 Binari	2,287
	2316	Profilo Lambiri	1,382
	2317	Profilo di Kulp	1,019
	2318	Profilo di Kulp	1,111

SERIE SCORREVOLE DIAMOND



BEPRO





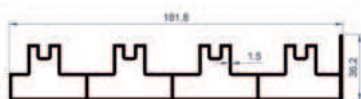
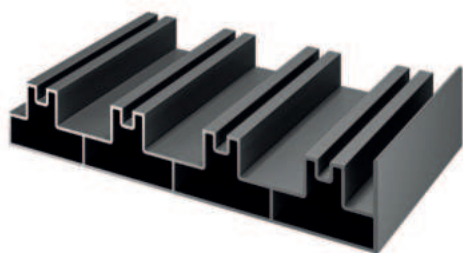

Profilo Inferiore e Superiore a 4 Guide

Codice Prodotto	2320
Peso (kg/mt)	2,512

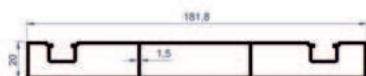
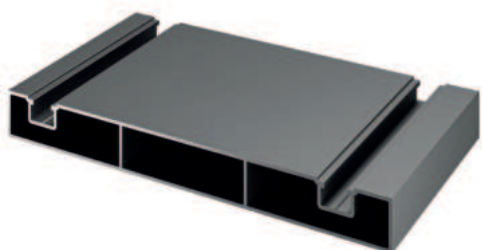

Profilo a 4 Montanti Lateral

Codice Prodotto	2321
Peso (kg/mt)	1,889

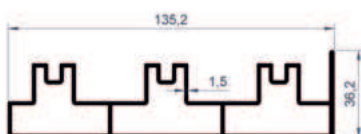
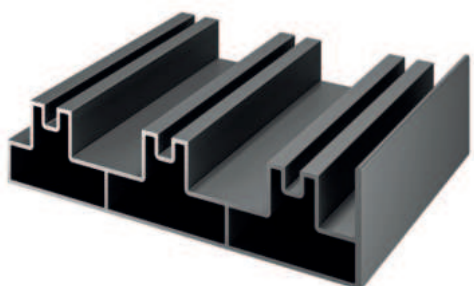

Profilo Inferiore e Superiore della Guida a 3 Pezzi

Codice Prodotto	2322
Peso (kg/mt)	1,919

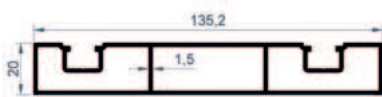
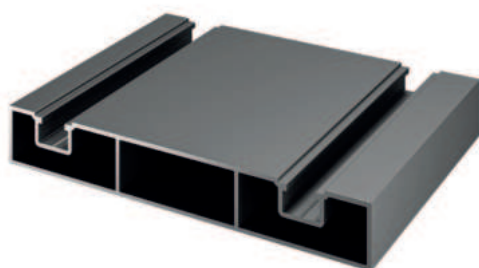

Profilo a 3 Montanti Lateral

Codice Prodotto	2323
Peso (kg/mt)	1,523

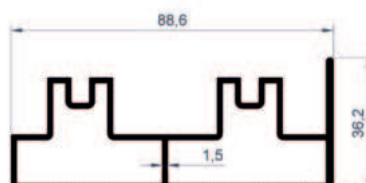
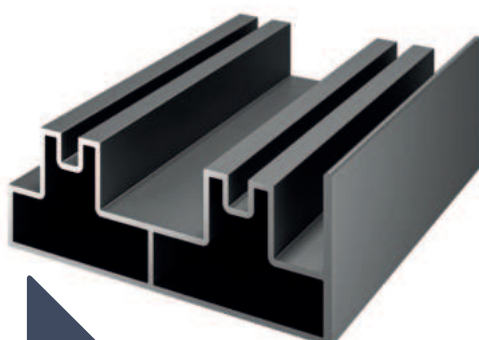

Profilo Inferiore e Superiore a 2 Binari

Codice Prodotto	2324
Peso (kg/mt)	1,328

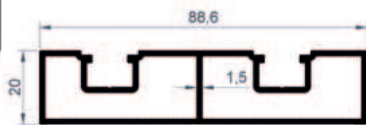
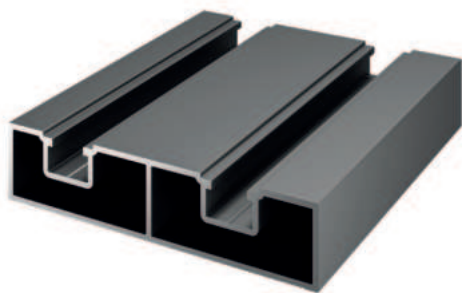

Profilo a 2 Montanti Laterali

Codice Prodotto	2325
Peso (kg/mt)	1,087

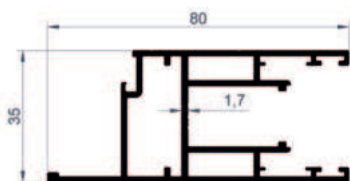
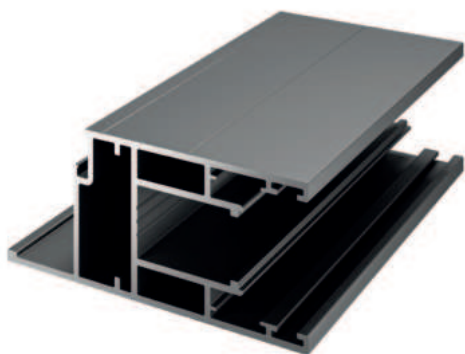

Profilo Dell'Anta In Vetro

Codice Prodotto	2326
Peso (kg/mt)	1,236

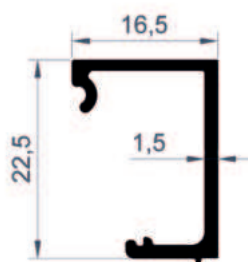

Fermavetro da 8 mm e 10 mm

Codice Prodotto	2327
Peso (kg/mt)	0,201

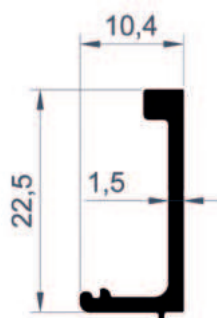

Fermavetro da 20 mm

Codice Prodotto	2328
Peso (kg/mt)	0,154

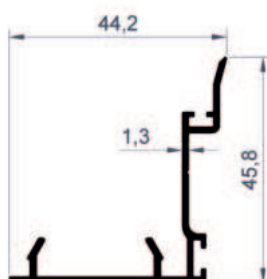

Profilo del Morsetto del Telaio

Codice Prodotto	2329
Peso (kg/mt)	0,417

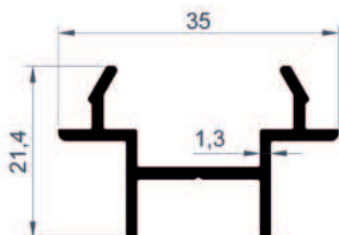
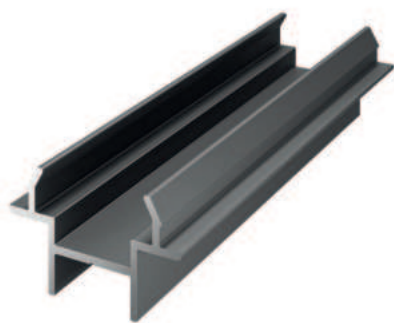

Profilo di Bloccaggio Centrale

Codice Prodotto	2330
Peso (kg/mt)	0,287

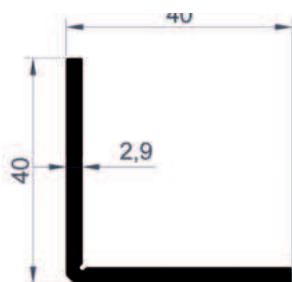

Profilo del Cuneo D'Angolo del Pannello

Codice Prodotto	2331
Peso (kg/mt)	0,591



Profilo della Guida della Ruota



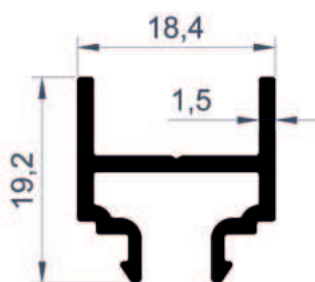







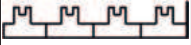

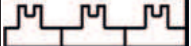
Codice Prodotto	2332
Peso (kg/mt)	0,130

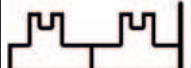
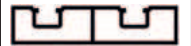

Profilo del Riscontro a Spagnoletta

Codice Prodotto	2333
Peso (kg/mt)	0,241



Profili Della Serie Scorrevole Diamond			
Immagine.	Profilo N.	Descrizione Del Profilo	Kg / mt
	2320	Profilo Inferiore e Superiore a 4 Guide	2,512
	2321	Profilo a 4 Montanti Laterali	1,889
	2322	Profilo Inferiore e Superiore della Guida a 3 Pezzi	1,919
	2323	Profilo a 3 Montanti Laterali	1,523
	2324	Profilo Inferiore e Superiore a 2 Binari	1,328
	2325	Profilo a 2 Montanti Laterali	1,087
	2326	Profilo Dell'Anta In Vetro	1,236
	2327	Fermavetro da 8 mm e 10 mm	0,201
	2328	Fermavetro da 20 mm	0,154
	2329	Profilo del Morsetto del Telaio	0,417
	2330	Profilo di Bloccaggio Centrale	0,287
	2331	Profilo del Cuneo D'Angolo del Pannello	0,591
	2332	Profilo della Guida della Ruota	0,130
	2333	Profilo del Riscontro a Spagnoletta	0,241

PROFILI STANDARD



40

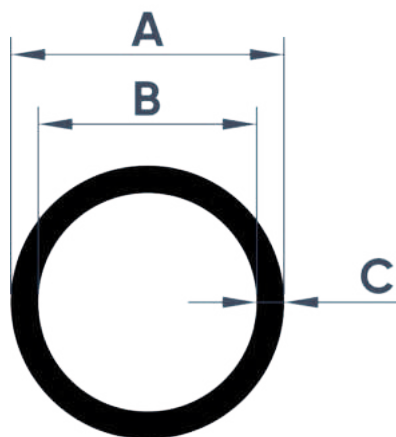

Profilo N.	A(mm)	B(mm)	C(mm)	kg/mt
1102	6	4	1	0,044
1103	8	6	1	0,060
1104	10	8	1	0,079
1105	10	7	1,5	0,111
1106	12	9	1,5	0,136
1100	16	14	1	0,132
1108	16	13	1,5	0,187
1109	19	16,6	1,2	0,185
1110	20	18	1	0,163
1111	22	20	1	0,179
1112	25	22,6	1,2	0,244
1113	25	21,4	1,8	0,360
1114	28	26	1	0,230
1115	32	29,6	1,2	0,318
1116	32	29	1,5	0,391
1117	32	28	2	0,513
1118	35	31,6	1,7	0,483
1119	35	31	2	0,564
1120	40	37,4	1,3	0,431
1121	42	38	2	0,683
1100	50	47,4	1,3	0,540
1122	60,1	56,9	1,6	0,799

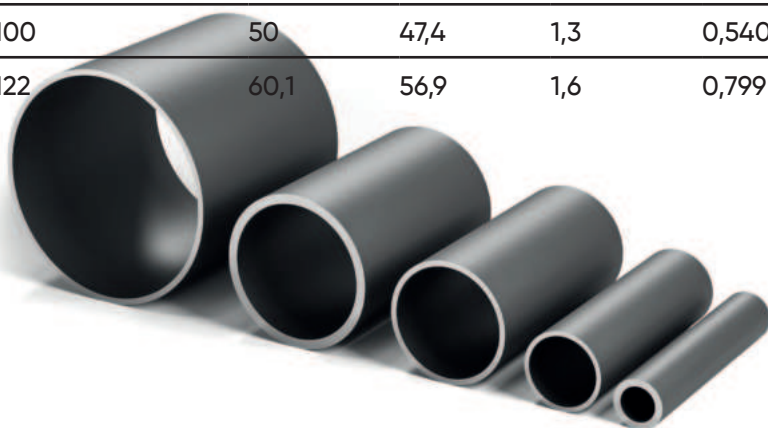



Profilo N.	A(mm)	B(mm)	C(mm)	kg/mt
1005	14	14	1,5	0,204
1006	15	30	1	0,233
1007	16	16	1,4	0,220
1008	17	25	1	0,217
1009	20	40	1,8	0,543
1010	20	20	1,5	0,301
1011	20	60	2	0,824
1012	20	40	1,3	0,404
1013	25	25	1,2	0,309
1014	25	80	1,2	0,666
1015	25	40	1,4	0,475
1016	30	30	1,2	0,374
1017	30	50	2	0,824
1018	30	70	1,5	0,789
1003	40	60	1,2	0,660
1002	40	40	1,1	0,481
2155	40	40	2	0,857
4154	40	80	2	1,257
4155	40	100	2	1,474
1021	50	130	1,4	1,347
1001	50	100	1,8	1,427
1022	60	60	2	1,261
1023	140	60	1,5	1,645

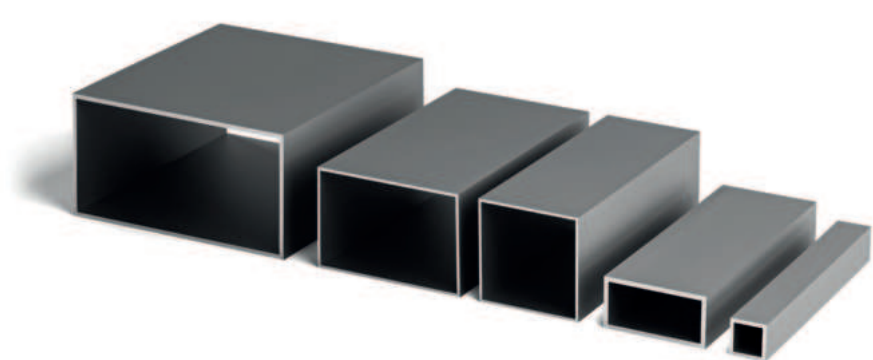

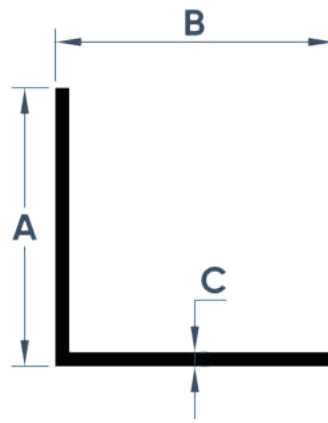

Profilo N.	A(mm)	B(mm)	C(mm)	kg/mt
1053	20	20	1,2	0,044
1050	20	40	1,2	0,060
1054	20	50	1,2	0,079
1051	20	60	1,2	0,111
1055	20	80	1,4	0,136
1056	25	25	1,2	0,132
1057	30	30	2	0,187
1058	50	50	1,5	0,185
G10000	39,9	39,9	2,85	0,163
1052	40	40	1,2	0,179
1059	40	40	2	0,244

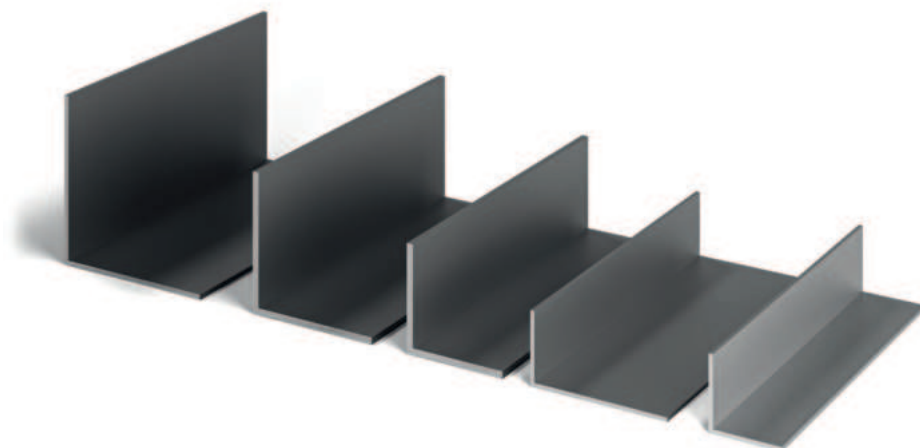

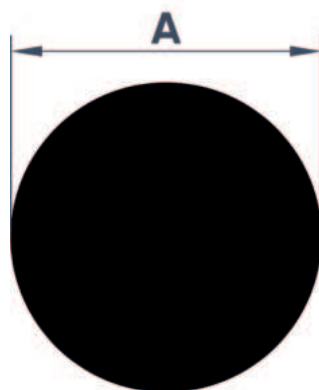

Profilo N.	A(mm)	kg/mt
1070	8	0,136
1071	10	0,215
1072	16	0,548
1073	20	0,851
1074	25	1,328
1075	30	1,916
1076	35	2,610
1077	40	3,407
1078	45	4,309
1079	50	5,325
1080	55	6,440
1081	59	7,662



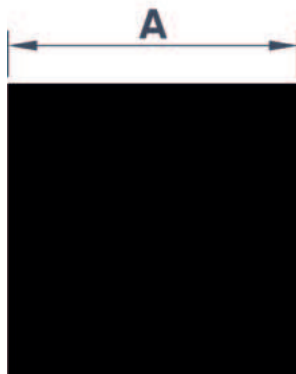

Profilo N.	A(mm)	kg/mt
1090	5	0,068
1091	6	0,095
1092	25	1,696
1093	30	2,440
1094	40	4,336
1095	50	6,775
1096	60	9,756
1097	80	17,344
1098	90	21,951
1099	100	27,100

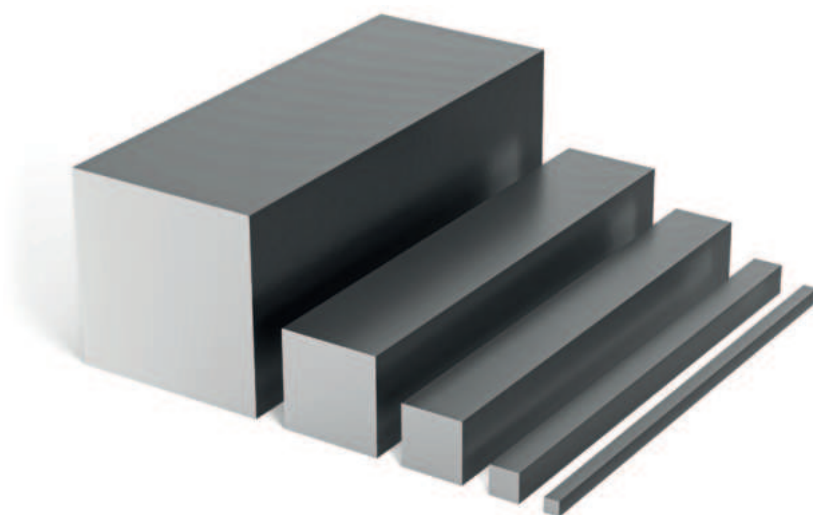



SERIE GARDEN FENCE

 **BEPRO**





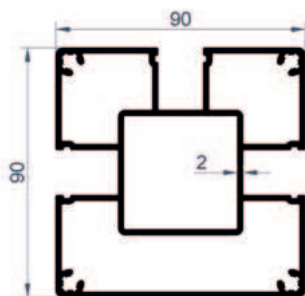
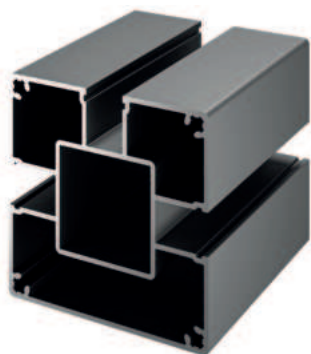

Profilo a Montante

Codice Prodotto	2144
Peso (kg/mt)	3,488



Profilo del Pannello

Codice Prodotto	2145
Peso (kg/mt)	1,420

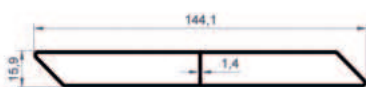

Profilo del Pannello

Codice Prodotto	2146
Peso (kg/mt)	1,141

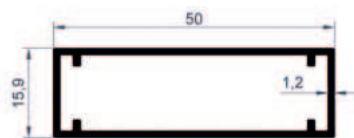

Profilo del Box

Codice Prodotto	2147
Peso (kg/mt)	0,442

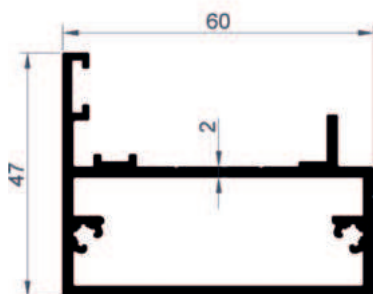
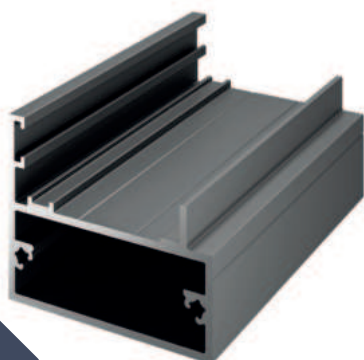

Profilo del Montante del Telaio Laterale della Porta

Codice Prodotto	2148
Peso (kg/mt)	1,236

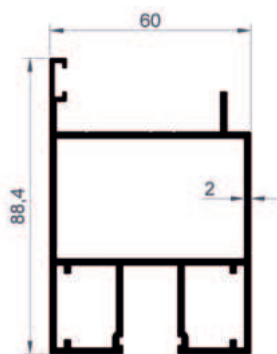

Profilo del Telaio Laterale della Porta

Codice Prodotto	2149
Peso (kg/mt)	2,076

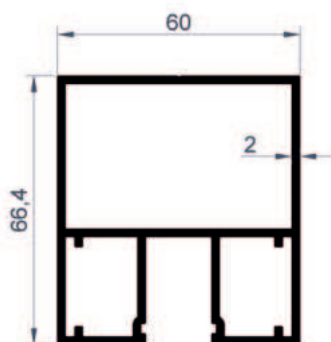

Profilo del Telaio Superiore Inferiore della Porta

Codice Prodotto	2150
Peso (kg/mt)	1,875

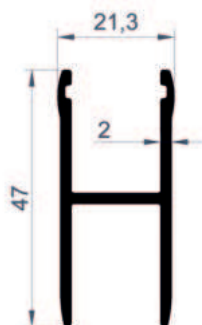

Profilo del Pannello di Vetro

Codice Prodotto	2151
Peso (kg/mt)	0,585

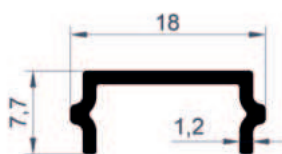
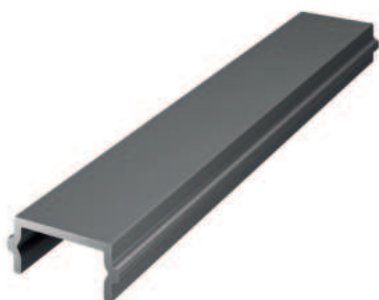

Profilo di Copertura a Puntone

Codice Prodotto	2152
Peso (kg/mt)	0,100

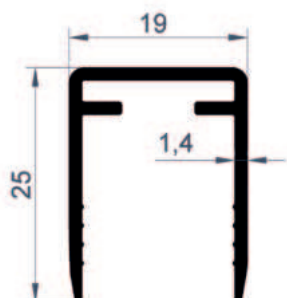

Profilo della Copertura Superiore del Pannello

Codice Prodotto	2153
Peso (kg/mt)	0,263

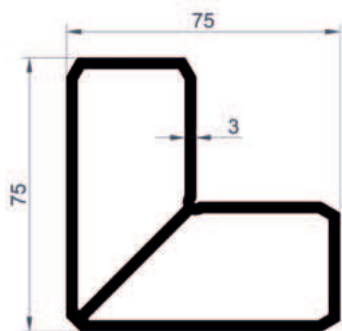
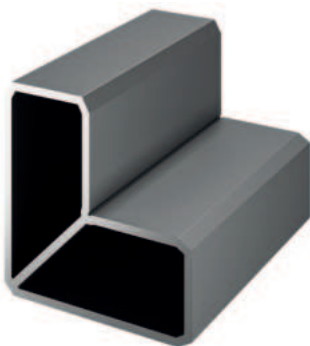

Profilo del Cuneo D'Angolo del Telaio della Porta

Codice Prodotto	2154
-----------------	------

Peso (kg/mt)	2,607
--------------	-------

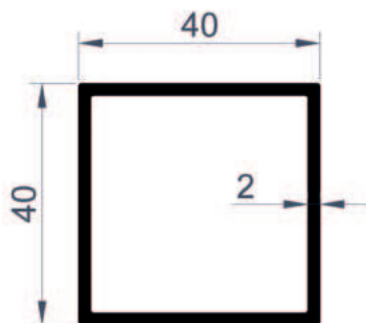











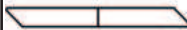

Profilo del Box

Codice Prodotto	2155
-----------------	------

Peso (kg/mt)	0,824
--------------	-------



Profili Della Serie Garden Fence			
Immagine.	Profilo N.	Descrizione Del Profilo	Kg / mt
	2144	Profilo a Montante	3,488
	2145	Profilo del Pannello	1,420
	2146	Profilo del Pannello	1,141
	2147	Profilo del Box	0,442
	2148	Profilo del Montante del Telaio Laterale della Porta	1,236
	2149	Profilo del Telaio Laterale della Porta	2,076
	2150	Profilo del Telaio Superiore Inferiore della Porta	1,875
	2151	Profilo del Pannello di Vetro	0,585
	2152	Profilo di Copertura a Puntone	0,100
	2153	Profilo della Copertura Superiore del Pannello	0,263
	2154	Profilo del Cuneo D'Angolo del Telaio della Porta	2,607
	2155	Profilo del Box	0,824



MOTORIZZATI DELLA SERIE BIOCLIMATIC



 **BEPRO**

55





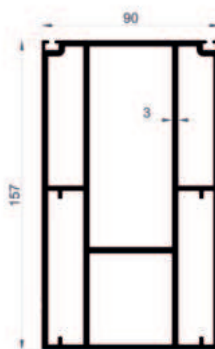

Profilo di Supporto della Guida Centrale

Codice Prodotto	2092
Peso (kg/mt)	7,003



Profilo del Pannello

Codice Prodotto	2093
Peso (kg/mt)	3,396

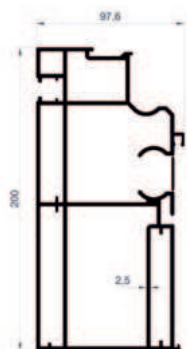

Profilo della Guida Laterale

Codice Prodotto	2094
Peso (kg/mt)	7,336

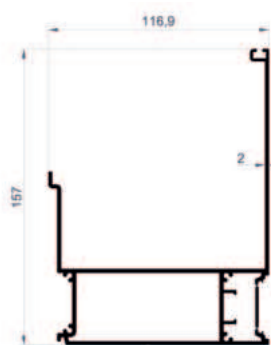

Profilo di Giunzione della Scanalatura della Guida

Codice Prodotto	2095
Peso (kg/mt)	2,978

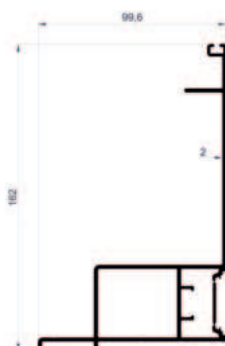

Profilo di Giunzione della Grondaia

Codice Prodotto	2096
Peso (kg/mt)	2,415

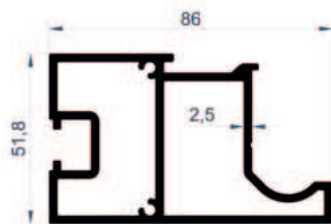
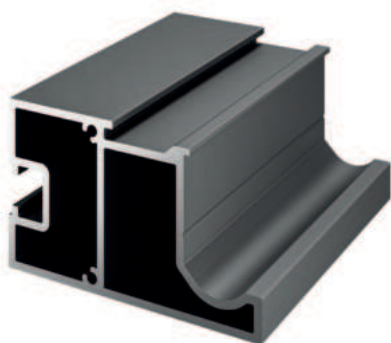

Profilo del Canale (C)

Codice Prodotto	2097
Peso (kg/mt)	2,393

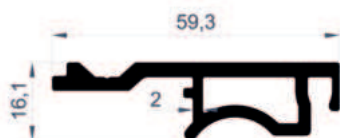
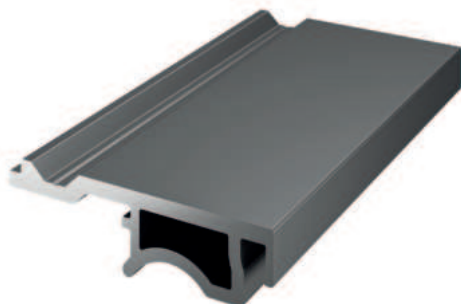

Profilo del Coperchio della Guida e del Canale (C)

Codice Prodotto	2098
Peso (kg/mt)	0,873

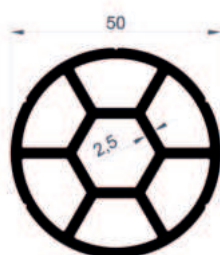

Profilo Albero Trasmissione Motore 6'Gen 1

Codice Prodotto	2099
Peso (kg/mt)	1,878

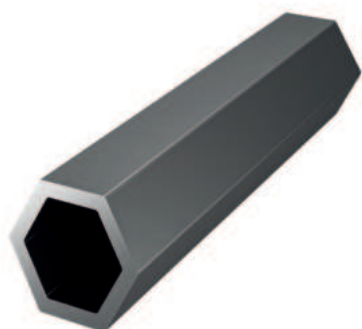

Profilo Albero Trasmissione Motore 6'Gen 2

Codice Prodotto	2100
Peso (kg/mt)	0,453



Profilo Albero Trasmissione Motore 6'Gen 3

Codice Prodotto	2101
Peso (kg/mt)	0,602

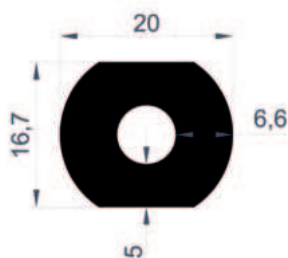

Profilo Albero Trasmissione Motore 6'Gen 4

Codice Prodotto	2103
Peso (kg/mt)	0,686



Profilo di Registrazione della Grondaia Superiore

Codice Prodotto	2112
Peso (kg/mt)	3,745

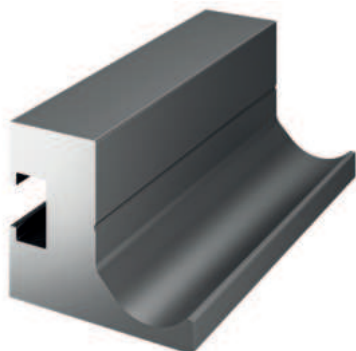

Profilo Albero Trasmissione Motore 6'Gen 5

Codice Prodotto	2156
Peso (kg/mt)	2,564



2 Moduli X24 Filettati

Codice Prodotto	2157
Peso (kg/mt)	3,705



2 Moduli X36 Filettati

Codice Prodotto	2158
Peso (kg/mt)	6,762



Profilo di Chiusura Laterale della Rotaia 1



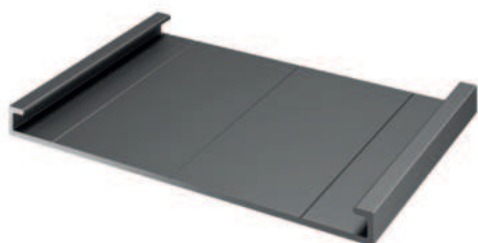











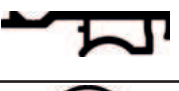

Codice Prodotto	2159
Peso (kg/mt)	1,797

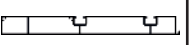

Profilo di Chiusura Laterale della Rotaia 2

Codice Prodotto	2160
Peso (kg/mt)	0,930

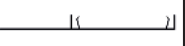

Profili Motorizzati Della Serie Bioclimatic			
Immagine.	Profilo N.	Descrizione Del Profilo	Kg / mt
	2092	Profilo di Supporto della Guida Centrale	7,003
	2093	Profilo del Pannello	3,396
	2094	Profilo della Guida Laterale	7,336
	2095	Profilo di Giunzione della Scanalatura della Guida	2,978
	2096	Profilo di Giunzione della Grondaia	2,415
	2097	Profilo del Canale (C)	2,393
	2098	Profilo del Coperchio della Guida e del Canale (C)	0,873
	2099	Profilo Albero Trasmissione Motore 6'Gen 1	1,878
	2100	Profilo Albero Trasmissione Motore 6'Gen 2	0,453
	2101	Profilo Albero Trasmissione Motore 6'Gen 3	0,602
	2103	Profilo Albero Trasmissione Motore 6'Gen 4	0,686
	2112	Profilo di Registrazione della Grondaia Superiore	3,745
	2156	Profilo Albero Trasmissione Motore 6'Gen 5	2,564
	2317	2 Moduli X24 Filettati	3,705
	2158	2 Moduli X36 Filettati	6,762
	2159	Profilo di Chiusura Laterale della Rotaia 1	1,715
	2160	Profilo di Chiusura Laterale della Rotaia 2	0,930

MANUALI DELLA SERIE BIOCLIMATIC



BEPRO





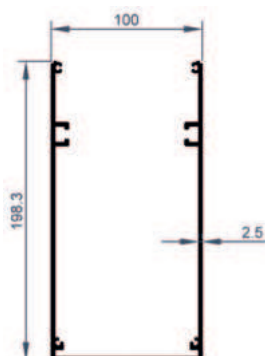

Profilo a Montante

Codice Prodotto	2104
Peso (kg/mt)	3,835



Profilo Portante Anteriore e Laterale

Codice Prodotto	2105
Peso (kg/mt)	5,233

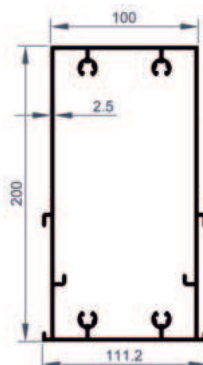

Profilo Portante Centrale

Codice Prodotto	2106
Peso (kg/mt)	5,461



Profilo del Pannello

Codice Prodotto	2107
Peso (kg/mt)	2,317

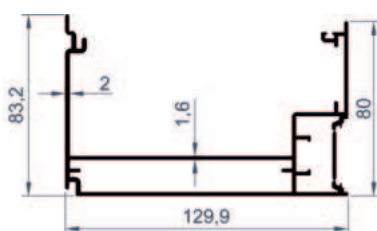

Profilo della Grondaia

Codice Prodotto	2108
Peso (kg/mt)	2,355

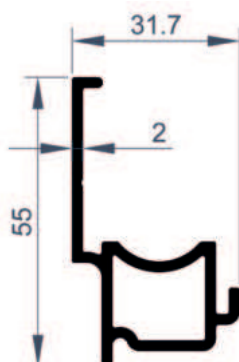

Profilo della Rotaia

Codice Prodotto	2109
Peso (kg/mt)	0,729

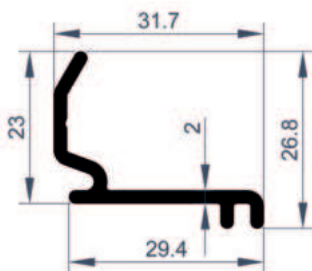
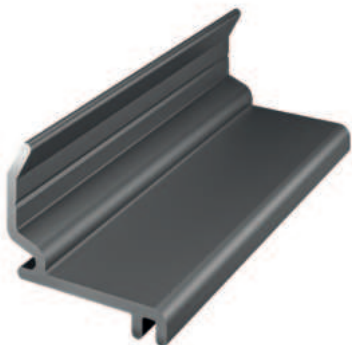

Profilo di Copertura della Guida

Codice Prodotto	2110
Peso (kg/mt)	0,331

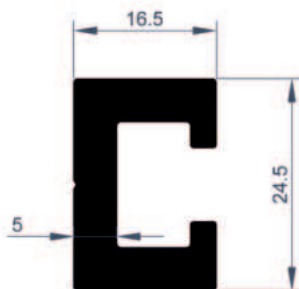

Profilo di Collegamento Superiore del Pannello



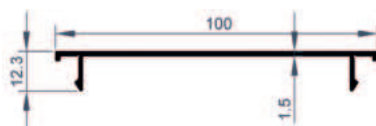
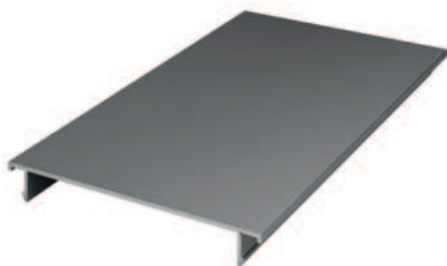





Codice Prodotto	2111
Peso (kg/mt)	0,691

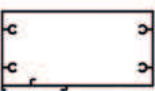

Profilo di Ancoraggio Inferiore del Montante

Codice Prodotto	2113
Peso (kg/mt)	0,501



Profili Manuali Della Serie Bioclimatic			
Immagine.	Profilo N.	Descrizione Del Profilo	Kg / mt
	2104	Profilo a Montante	3,835
	2105	Profilo Portante Anteriore e Laterale	5,233
	2106	Profilo Portante Centrale	5,461
	2107	Profilo del Pannello	2,317
	2108	Profilo della Grondaia	2,355
	2109	Profilo della Rotaia	0,729
	2110	Profilo di Copertura della Guida	0,331
	2111	Profilo di Collegamento Superiore del Pannello	0,691
	2113	Profilo di Ancoraggio Inferiore del Montante	0,501

SERIE DI TENDE DA SOFFITTO

 **BEPRO**

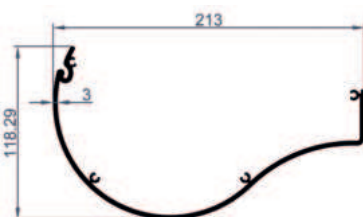

Profilo Scatola Motore

Codice Prodotto	2080
Peso (kg/mt)	3,133

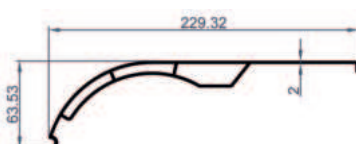
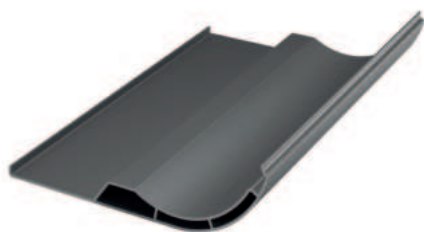

Profilo di Copertura della Scatola Motore

Codice Prodotto	2081
Peso (kg/mt)	2,412

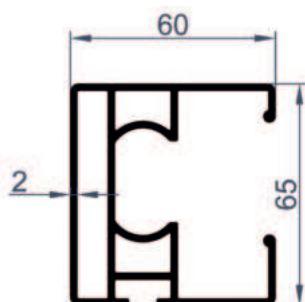
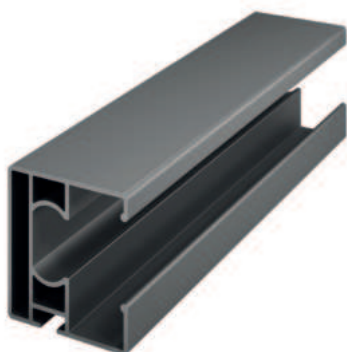

Profilo della Rotaia

Codice Prodotto	2082
Peso (kg/mt)	1,916

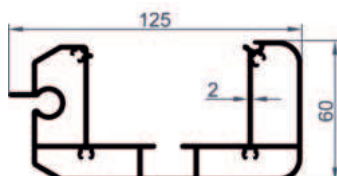

Profilo di Traino Anteriore

Codice Prodotto	2083
Peso (kg/mt)	2,873

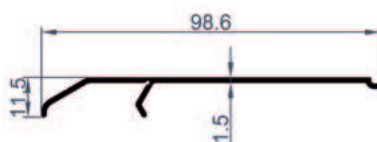
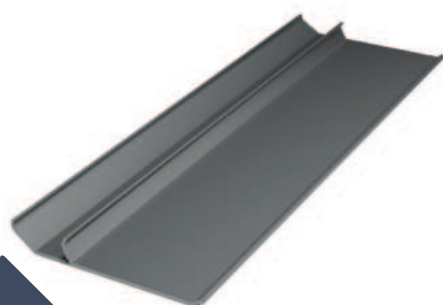

Profilo della Copertura Anteriore Attraente

Codice Prodotto	2084
Peso (kg/mt)	0,463

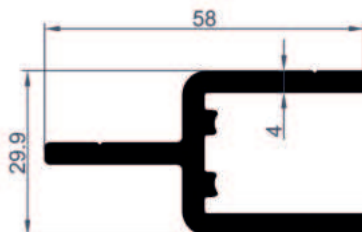

Profilo del Tenditore a Molla Singola

Codice Prodotto	2085
Peso (kg/mt)	1,247

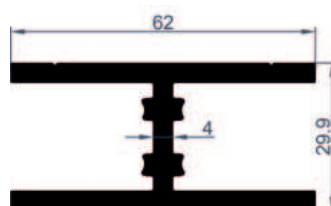

Profilo del Tensionatore a Doppia Molla



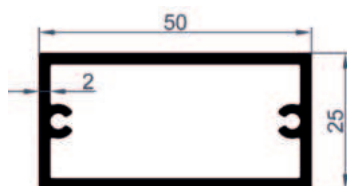





Codice Prodotto	2086
Peso (kg/mt)	1,677



Profilo della Scatola del Montante

Codice Prodotto	2087
Peso (kg/mt)	0,840



Profili Delle Serie Di Tende Da Soffitto			
Immagine.	Profilo N.	Descrizione Del Profilo	Kg / mt
	2080	Profilo Scatola Motore	3,133
	2081	Profilo di Copertura della Scatola Motore	2,412
	2082	Profilo della Rotaia	1,916
	2083	Profilo di Traino Anteriore	2,873
	2084	Profilo della Copertura Anteriore Attraente	0,463
	2085	Profilo del Tenditore a Molla Singola	1,247
	2086	Profilo del Tensionatore a Doppia Molla	1,677
	2087	Profilo della Scatola del Montante	0,840

SERIE C60

 BEPRO

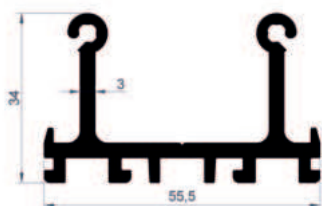

Profilo Adattatore, Connessione Verticale

Codice Prodotto	1516
Peso (kg/mt)	1,201

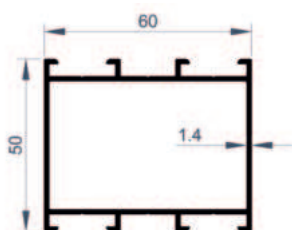

Profilo Telaio e Cassa

Codice Prodotto	1500
Peso (kg/mt)	0,959

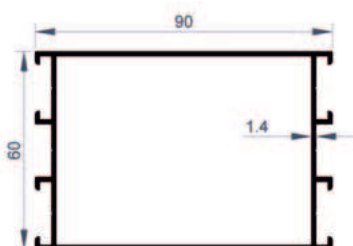

Profilo Telaio e Cassa

Codice Prodotto	1501
Peso (kg/mt)	1,262

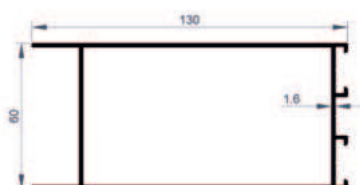

Profilo Per Davanzale Fisso

Codice Prodotto	1502
Peso (kg/mt)	1,688

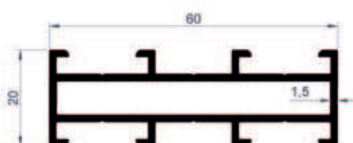

Profilo Telaio e Cassa

Codice Prodotto	1503
Peso (kg/mt)	0,767

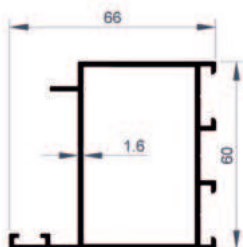
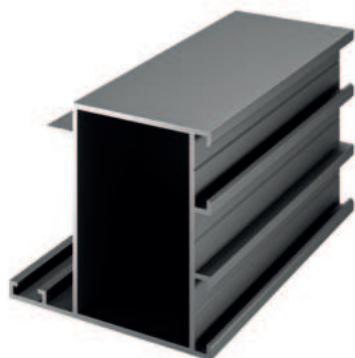

Profilo Dell'Anta

Codice Prodotto	1504
Peso (kg/mt)	1,098

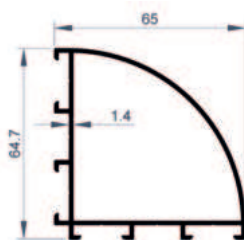
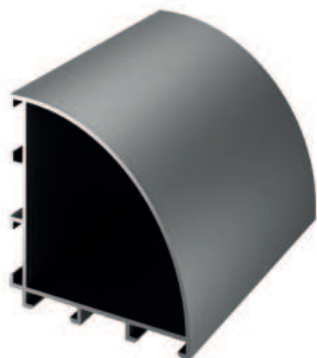

Profilo D'Angolo

Codice Prodotto	1505
Peso (kg/mt)	1,016

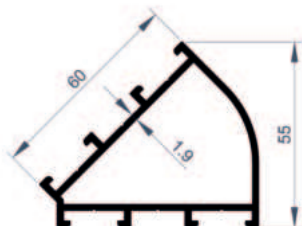
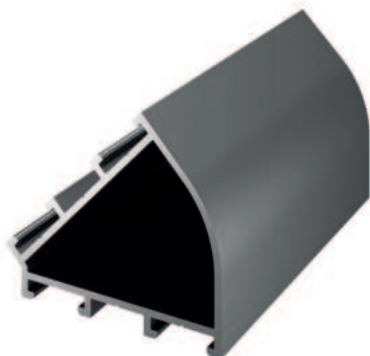

Profilo D'Angolo

Codice Prodotto	1506
Peso (kg/mt)	1,173

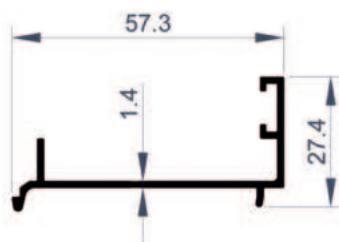

Profilo Adattatore del Telaio

Codice Prodotto	1507
Peso (kg/mt)	0,404

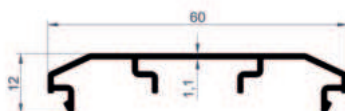
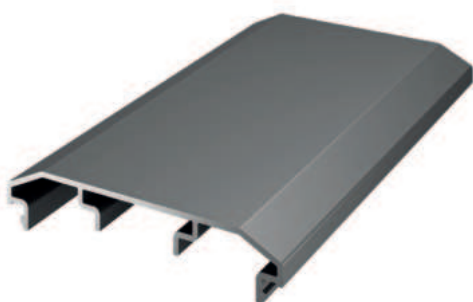

Profilo Adattatore del Telaio di Ritorno

Codice Prodotto	1508
Peso (kg/mt)	0,317

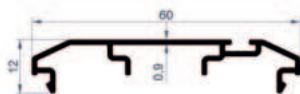
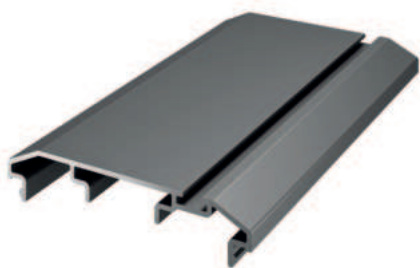

Profilo Adattatore del Telaio di Ritorno

Codice Prodotto	1509
Peso (kg/mt)	0,333

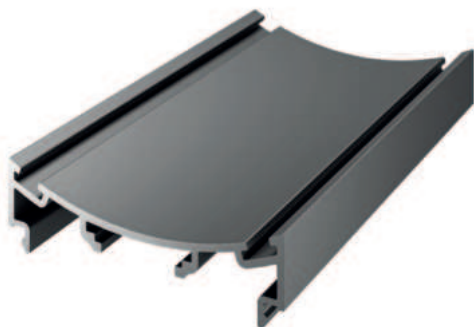

Profilo Adattatore del Telaio di Ritorno

Codice Prodotto	1510
Peso (kg/mt)	0,478

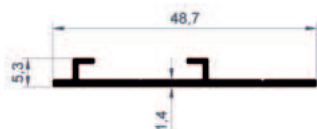

Profilo Adattatore Per Finestra

Codice Prodotto	1511
Peso (kg/mt)	0,222

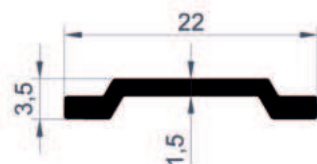

Profilo Dell'Asta

Codice Prodotto	1512
Peso (kg/mt)	0,108

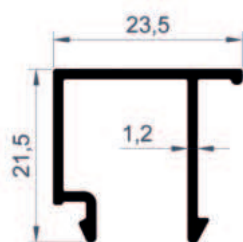

Profilo a Goccia In Vetro

Codice Prodotto	1513
Peso (kg/mt)	0,233

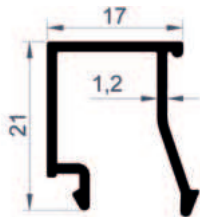

Profilo a Goccia In Vetro



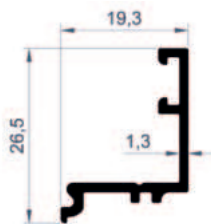







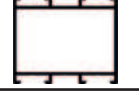

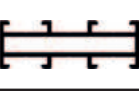

Codice Prodotto	1514
Peso (kg/mt)	0,211



Profilo a Goccia In Vetro

Codice Prodotto	1515
Peso (kg/mt)	0,205



Profili Serie C60			
Immagine.	Profilo N.	Descrizione Del Profilo	Kg / mt
	1516	Profilo Adattatore, Connessione Verticale	1,201
	1500	Profilo Telaio e Cassa	0,959
	1501	Profilo Telaio e Cassa	1,262
	1502	Profilo Per Davanzale Fisso	1,688
	1503	Profilo Telaio e Cassa	0,767
	1504	Profilo Dell'Anta	1,098
	1505	Profilo D'Angolo	1,016
	1506	Profilo D'Angolo	1,173
	1507	Profilo Adattatore del Telaio	0,404
	1508	Profilo Adattatore del Telaio di Ritorno	0,317
	1509	Profilo Adattatore del Telaio di Ritorno	0,333
	1510	Profilo Adattatore del Telaio di Ritorno	0,478
	1511	Profilo Adattatore Per Finestra	0,222
	1512	Profilo Dell'Asta	0,108
	1513	Profilo a Goccia In Vetro	0,233
	1514	Profilo a Goccia In Vetro	0,211
	1515	Profilo a Goccia In Vetro	0,205

SERIE ALDOKS

 BEPRO

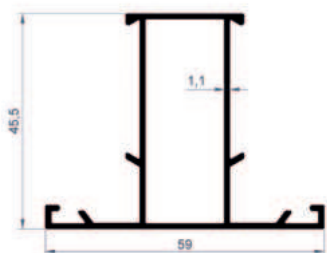

Profilo della Guida di Intersezione Stretta

Codice Prodotto	1550
Peso (kg/mt)	0,607

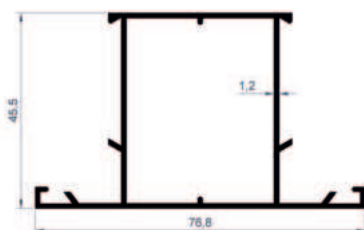

Profilo della Guida di Intersezione Stretta

Codice Prodotto	1551
Peso (kg/mt)	0,759

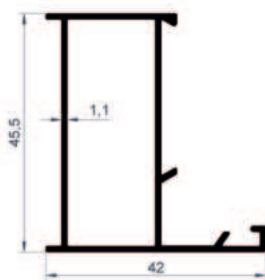

Profilo del Telaio Stretto

Codice Prodotto	1552
Peso (kg/mt)	0,507

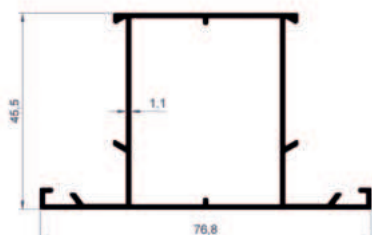

Profilo della Guida di Intersezione

Codice Prodotto	1553
Peso (kg/mt)	0,718

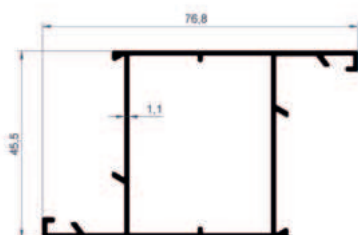

Profilo Ad Ala Larga

Codice Prodotto	1554
Peso (kg/mt)	0,718

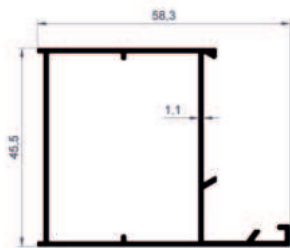
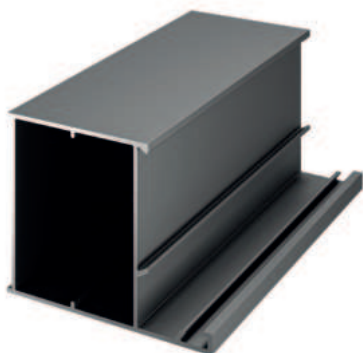

Profilo a Cassa Larga

Codice Prodotto	1555
Peso (kg/mt)	0,615



Profilo della Guida di Intersezione

Codice Prodotto	1556
Peso (kg/mt)	1,122

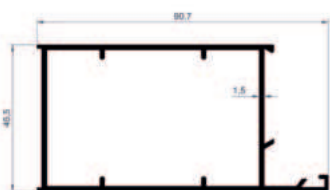
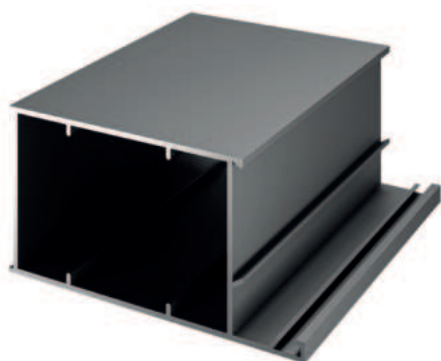

Profilo a Cassa Larga

Codice Prodotto	1557
Peso (kg/mt)	1,087

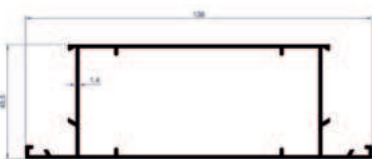

Profilo della Guida di Intersezione del Telaio Largo

Codice Prodotto	1558
Peso (kg/mt)	1,379

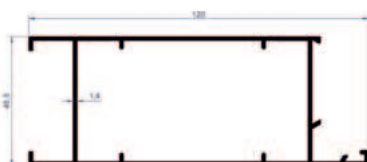

Profilo Largo della Soglia della Porta

Codice Prodotto	1559
Peso (kg/mt)	1,285

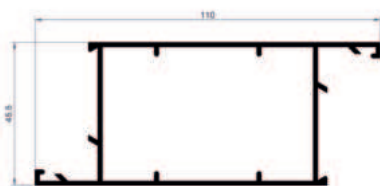

Profilo a Cassa Larga

Codice Prodotto	1560
Peso (kg/mt)	1,176

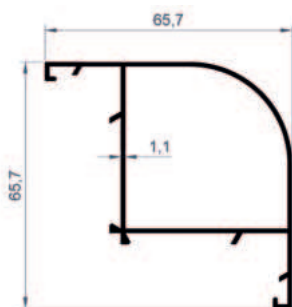

Profilo Angolare a 90°

Codice Prodotto	1561
Peso (kg/mt)	0,718

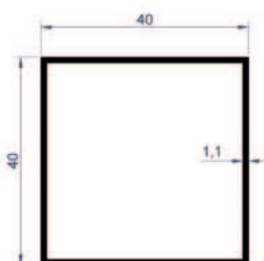

Profilo del Box

Codice Prodotto	1562
Peso (kg/mt)	0,463

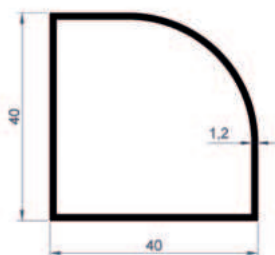
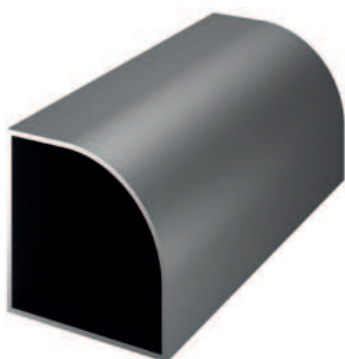

Profilo Scatolato a Raggio

Codice Prodotto	1563
Peso (kg/mt)	0,472

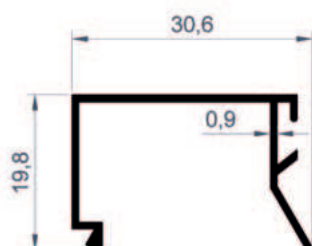
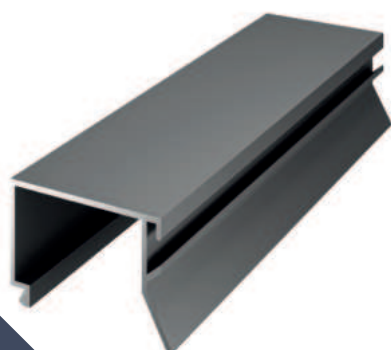

Profilo Dello Stoppino di Vetro

Codice Prodotto	1564
Peso (kg/mt)	0,198

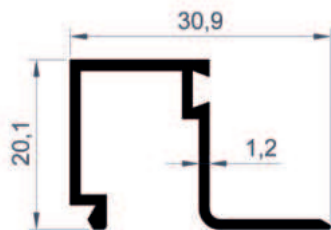

Profilo Delle Barre Intermedie

Codice Prodotto	1565
Peso (kg/mt)	0,249

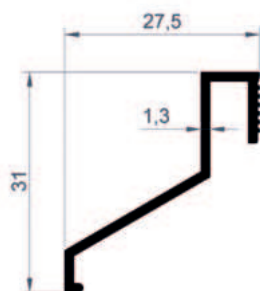

Profilo del Bordo di Gocciolamento

Codice Prodotto	1566
Peso (kg/mt)	0,211

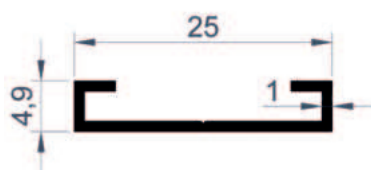

Profilo Asta Spagnet

Codice Prodotto	1567
Peso (kg/mt)	0,106

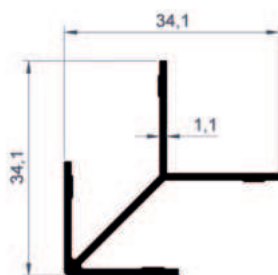

Profilo Asta Spagnet

Codice Prodotto	1568
Peso (kg/mt)	0,285

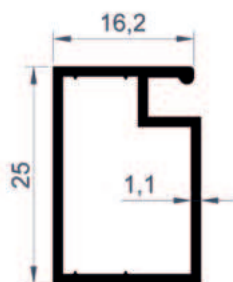
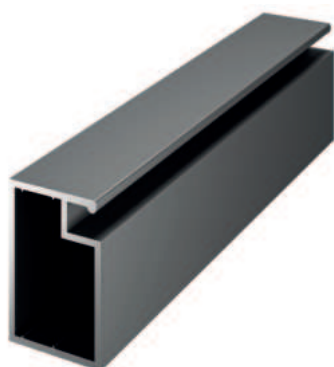







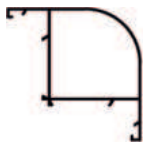
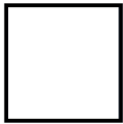

Profilo Telaio Zanzariera

Codice Prodotto	1569
Peso (kg/mt)	0,257



Profili Serie Aldoks			
Immagine.	Profilo N.	Descrizione Del Profilo	Kg / mt
	1550	Profilo della Guida di Intersezione Stretta	0,607
	1551	Profilo della Guida di Intersezione Stretta	0,759
	1552	Profilo del Telaio Stretto	0,507
	1553	Profilo della Guida di Intersezione	0,718
	1554	Profilo Ad Ala Larga	0,718
	1555	Profilo a Cassa Larga	0,615
	1556	Profilo della Guida di Intersezione	1,122
	1557	Profilo a Cassa Larga	1,087
	1558	Profilo della Guida di Intersezione del Telaio Largo	1,379
	1559	Profilo Largo della Soglia della Porta	1,285



Immagine.	Profilo N.	Descrizione Del Profilo	Kg / mt
	1560	Profilo a Cassa Larga	1,176
	1561	Profilo Angolare a 90°	0,718
	1562	Profilo del Box	0,463
	1563	Profilo Scatolato a Raggio	0,472
	1564	Profilo Dello Stoppino di Vetro	0,198
	1565	Profilo Delle Barre Intermedie	0,249
	1566	Profilo del Bordo di Gocciolamento	0,211
	1567	Profilo Asta Spagnet	0,106
	1568	Profilo Asta Spagnet	0,285
	1569	Profilo Telaio Zanzariera	0,257

PROFILI DEI DAVANZALI

 **BEPRO**

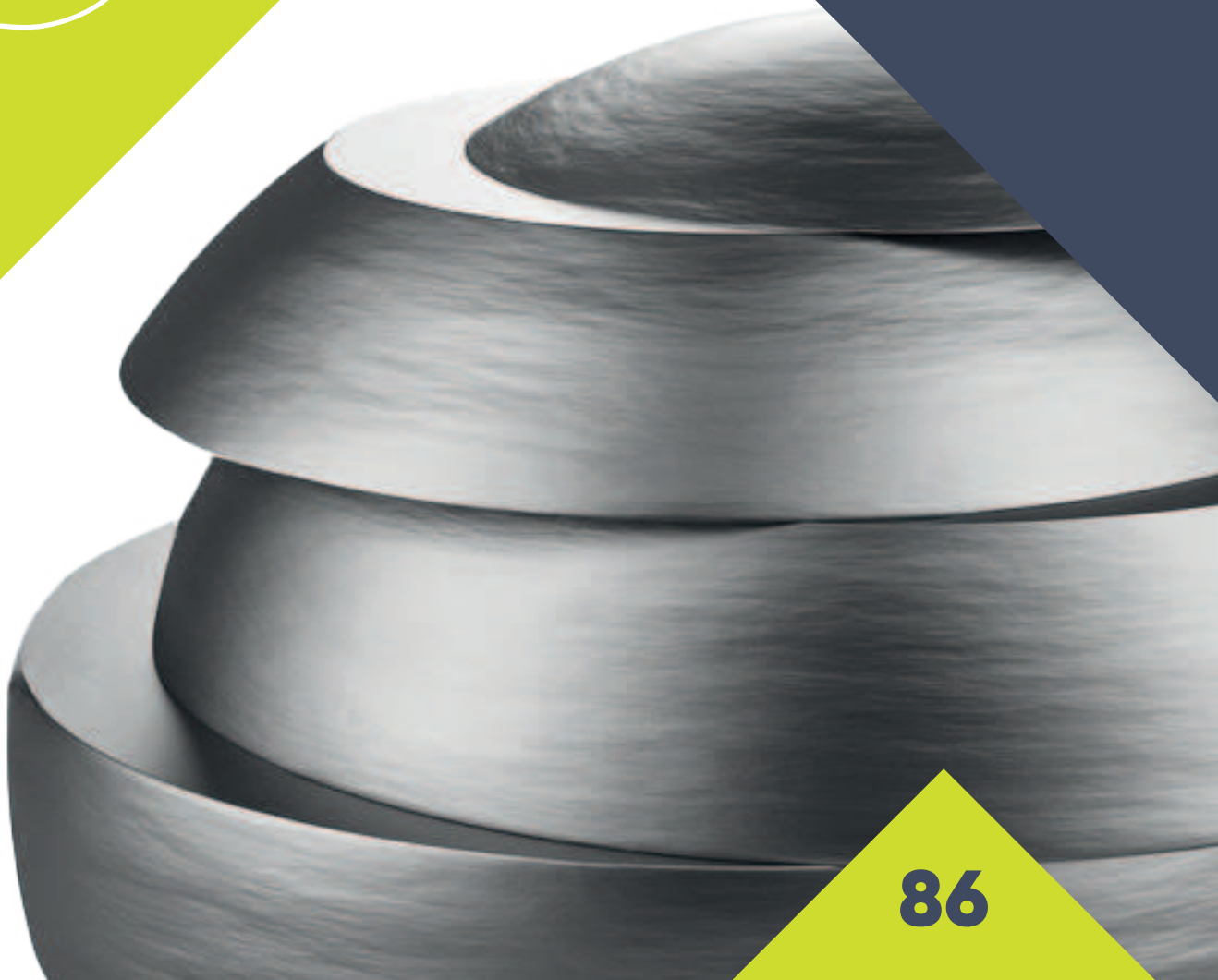

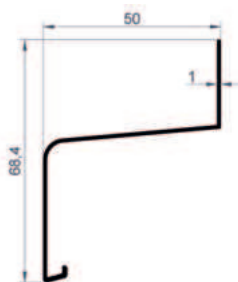

Profilo Davanzale 50

Codice Prodotto	3200
Peso (kg/mt)	0,328

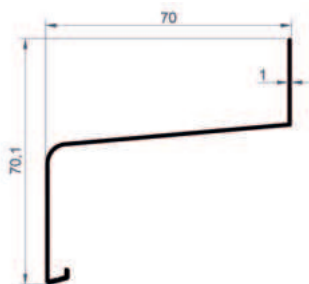
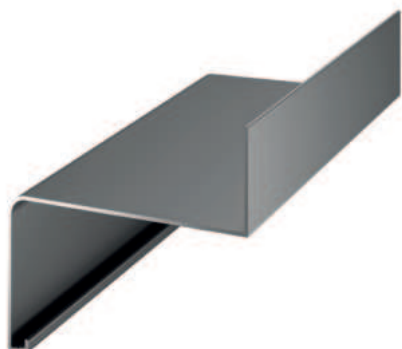

Profilo Davanzale 70

Codice Prodotto	3201
Peso (kg/mt)	0,382

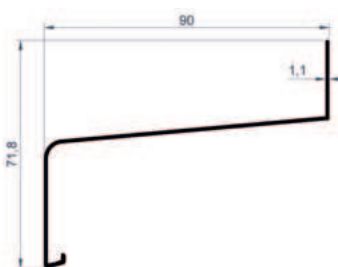
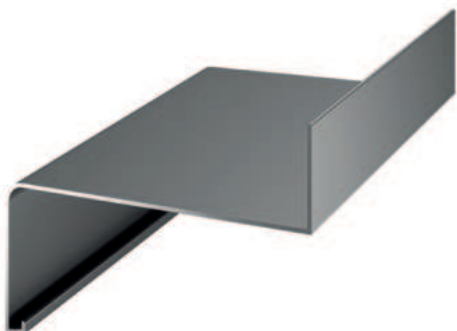

Profilo Davanzale 90

Codice Prodotto	3202
Peso (kg/mt)	0,477

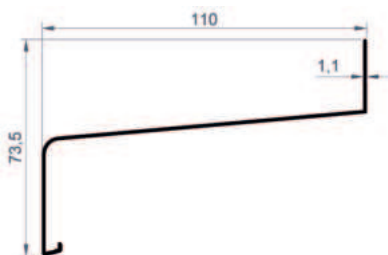
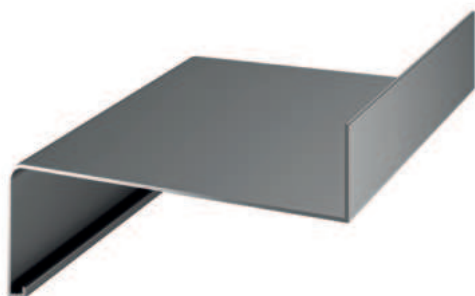

Profilo Davanzale 110

Codice Prodotto	3203
Peso (kg/mt)	0,537

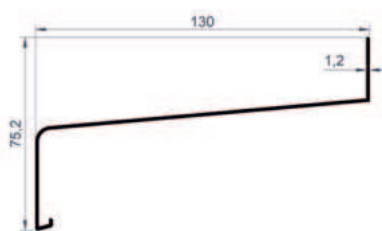

Profilo Davanzale 110

Codice Prodotto	3204
Peso (kg/mt)	0,648

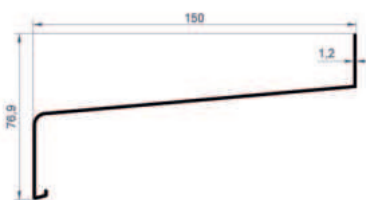
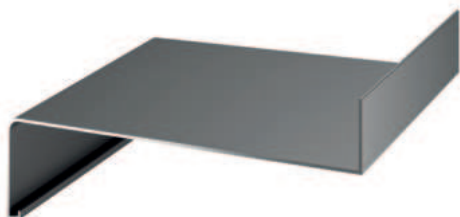

Profilo Davanzale 150

Codice Prodotto	3205
Peso (kg/mt)	0,740



Profilo Davanzale 165

Codice Prodotto	3206
Peso (kg/mt)	0,821

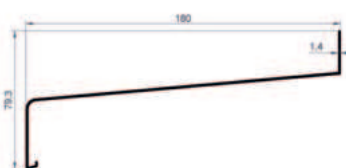

Profilo Davanzale 180

Codice Prodotto	3207
Peso (kg/mt)	0,940



Profilo Davanzale 195

Codice Prodotto	3208
Peso (kg/mt)	0,997



Profilo Davanzale 210

Codice Prodotto	3209
Peso (kg/mt)	1,127

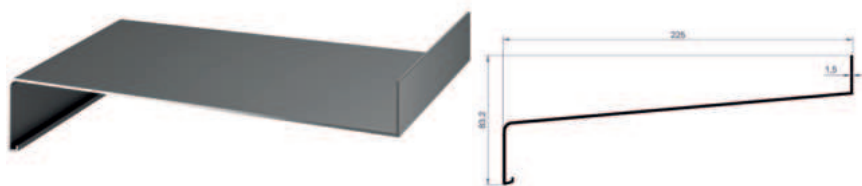

Profilo Davanzale 225

Codice Prodotto	3210
Peso (kg/mt)	1,187

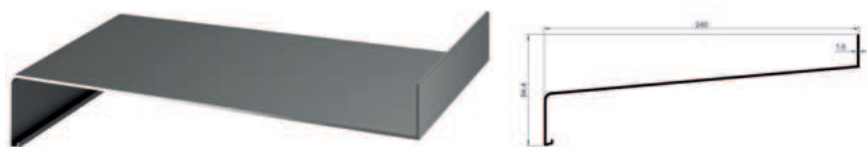

Profilo Davanzale 240



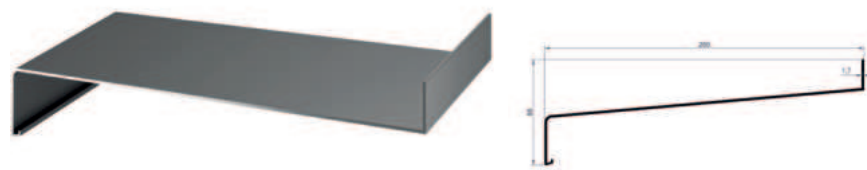









Codice Prodotto	3211
Peso (kg/mt)	1,327



Profilo Davanzale 260

Codice Prodotto	3212
Peso (kg/mt)	1,501



Profili Dei Davanzali			
Immagine.	Profilo N.	Descrizione Del Profilo	Kg / mt
	3200	Profilo Davanzale 50	0,328
	3201	Profilo Davanzale 70	0,382
	3202	Profilo Davanzale 90	0,477
	3203	Profilo Davanzale 110	0,537
	3204	Profilo Davanzale 110	0,648
	3205	Profilo Davanzale 150	0,740
	3206	Profilo Davanzale 165	0,821
	3207	Profilo Davanzale 180	0,940
	3208	Profilo Davanzale 195	0,997
	3209	Profilo Davanzale 210	1,127
	3210	Profilo Davanzale 225	1,187
	3211	Profilo Davanzale 240	1,327
	3212	Profilo Davanzale 260	1,501

SERIE CORRIMANO

 **BEPRO**

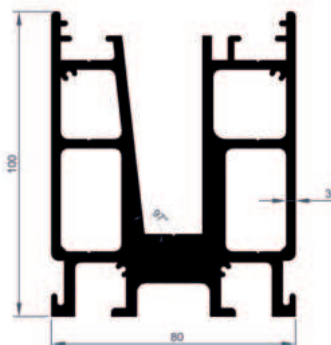

Profilo di Fondo a Cuneo

Codice Prodotto	4023
Peso (kg/mt)	6,545



Profilo di Copertura Inferiore a Cuneo

Codice Prodotto	4024
Peso (kg/mt)	0,648

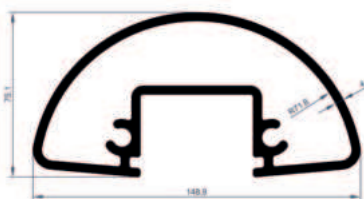

Profilo Dello Zoccolo Superiore a Cuneo

Codice Prodotto	4025
Peso (kg/mt)	0,824

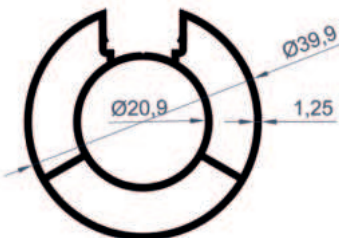

40 Profilo del Montante

Codice Prodotto	4100
Peso (kg/mt)	0,705



Profilo di Copertura

Codice Prodotto	4101
Peso (kg/mt)	0,065

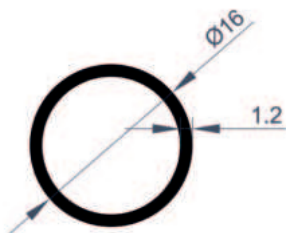

16 Profilo del Tubo

Codice Prodotto	4102
Peso (kg/mt)	0,152

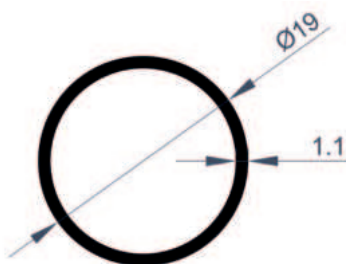

19 Profilo del Tubo

Codice Prodotto	4103
Peso (kg/mt)	0,168

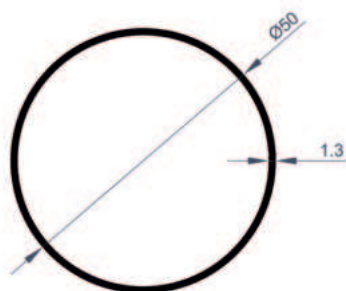
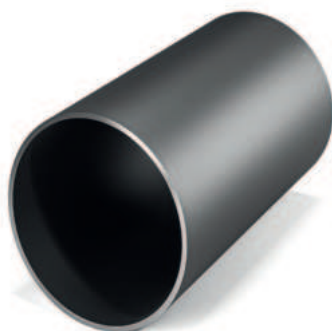

50 Profilo del Tubo

Codice Prodotto	4104
Peso (kg/mt)	0,537

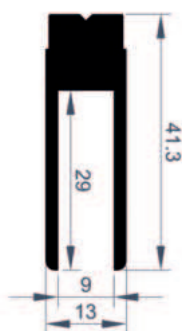

Profilo Portavetro

Codice Prodotto	4105
Peso (kg/mt)	0,726

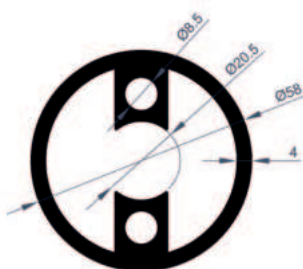

Profilo di Connessione

Codice Prodotto	4106
Peso (kg/mt)	2,688

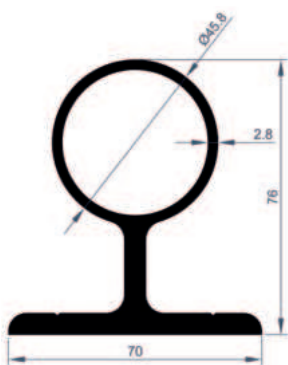

Profilo di Connessione

Codice Prodotto	4107
Peso (kg/mt)	2,572

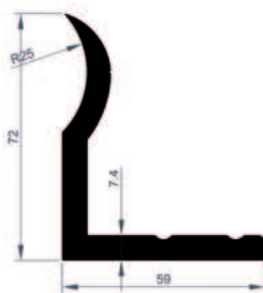
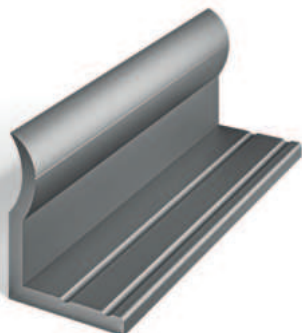

Profilo a L del Portatore

Codice Prodotto	4108
Peso (kg/mt)	2,374

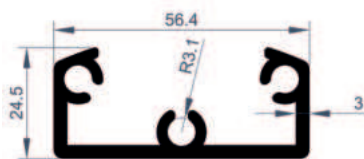

Profilo di Connessione

Codice Prodotto	4109
Peso (kg/mt)	1,089

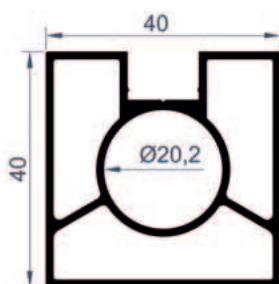
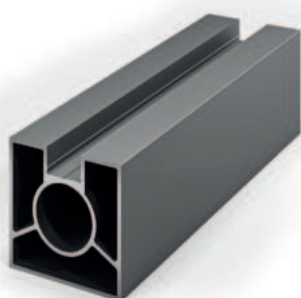

Profilo a Montante Quadrato 40X40

Codice Prodotto	4110
Peso (kg/mt)	0,916

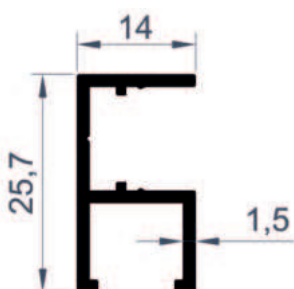

Profilo F

Codice Prodotto	4111
Peso (kg/mt)	0,263

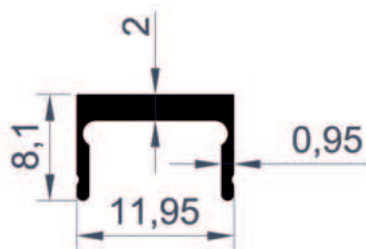
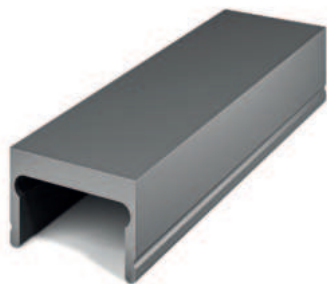

Profilo di Copertura

Codice Prodotto	4112
Peso (kg/mt)	0,092

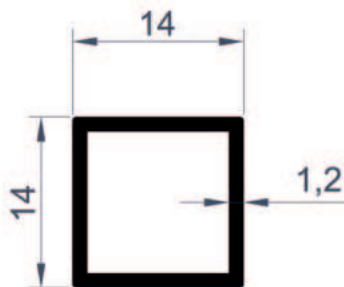
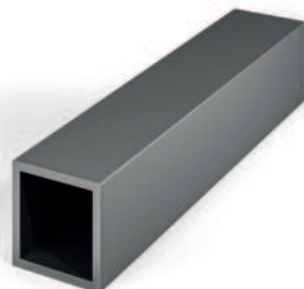

Profilo Box 14X14

Codice Prodotto	4113
Peso (kg/mt)	0,165

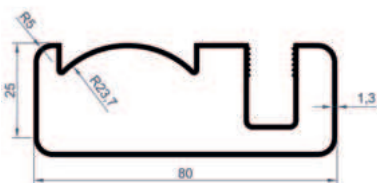
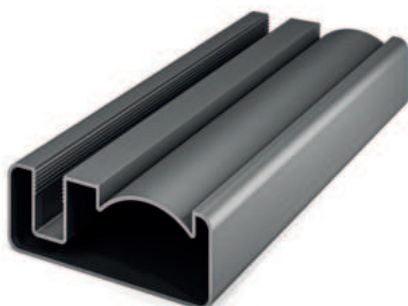

80 Profilo Dello Zoccolo Superiore

Codice Prodotto	4114
Peso (kg/mt)	0,949

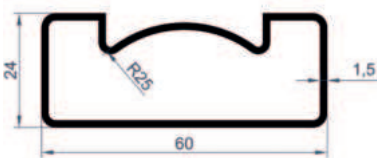
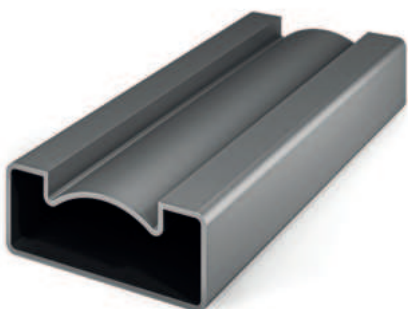

60 Profilo Dello Zoccolo Superiore

Codice Prodotto	4115
Peso (kg/mt)	0,705

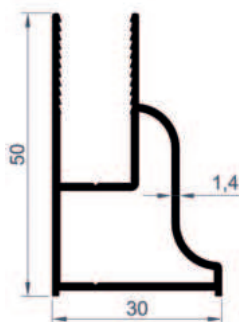
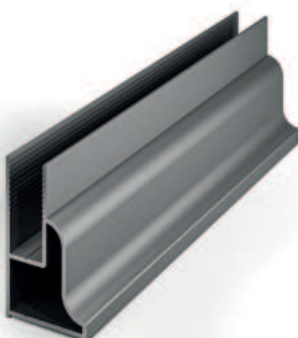

Profilo di Fondo a Cuneo

Codice Prodotto	4116
Peso (kg/mt)	0,607

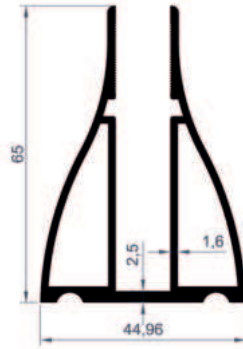

Profilo di Fondo a Cuneo

Codice Prodotto	4117
Peso (kg/mt)	1,282















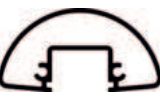







Profili Della Serie Corrimano			
Immagine.	Profilo N.	Descrizione Del Profilo	Kg / mt
	4023	Profilo di Fondo a Cuneo	6,545
	4024	Profilo di Copertura Inferiore a Cuneo	0,648
	4025	Profilo Dello Zoccolo Superiore a Cuneo	0,824
	4100	40 Profilo del Montante	0,705
	4101	Profilo di Copertura	0,065
	4102	16 Profilo del Tubo	0,152
	4103	19 Profilo del Tubo	0,168
	4104	50 Profilo del Tubo	0,537
	4105	Profilo Portavetro	0,726
	4106	Profilo di Connessione	2,688

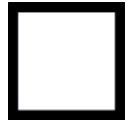

Immagine.	Profilo N.	Descrizione Del Profilo	Kg / mt
	4107	Profilo di Connessione	2,572
	4108	Profilo a L del Portatore	2,374
	4109	Profilo di Connessione	1,089
	4110	Profilo a Montante Quadrato 40X40	0,916
	4111	Profilo F	0,263
	4112	Profilo di Copertura	0,092
	4113	Profilo Box 14X14	0,165
	4114	80 Profilo Dello Zoccolo Superiore	0,949
	4115	60 Profilo Dello Zoccolo Superiore	0,705
	4116	Profilo di Fondo a Cuneo	0,607
	4117	Profilo di Fondo a Cuneo	1,282

BALCONI IN VETRO

 **BEPRO**

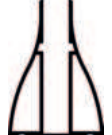
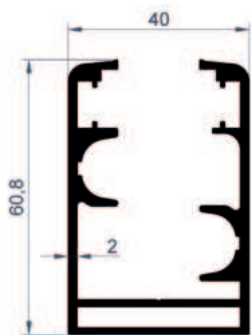

Profilo della Rotaia

Codice Prodotto	4118
Peso (kg/mt)	1,425

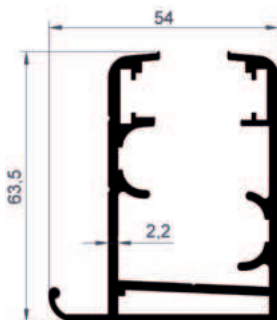

Profilo della Rotaia

Codice Prodotto	4119
Peso (kg/mt)	1,575

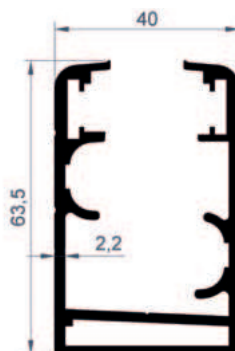

Profilo della Rotaia

Codice Prodotto	4120
Peso (kg/mt)	1,496

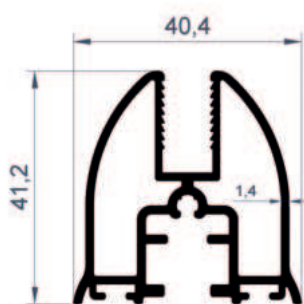

Pannello Profilo Superiore e Inferiore

Codice Prodotto	4121
Peso (kg/mt)	0,916

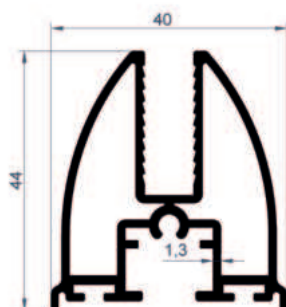

Pannello Profilo Superiore e Inferiore

Codice Prodotto	4122
Peso (kg/mt)	0,883

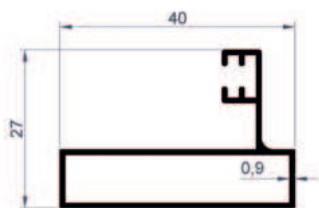

Profilo del Montante del Telaio Laterale Stretto

Codice Prodotto	4123
Peso (kg/mt)	0,325

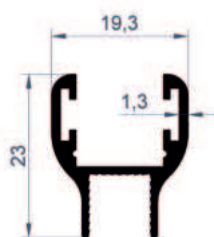

(H) Profilo del Listello



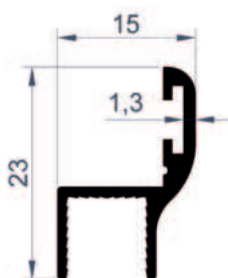





Codice Prodotto	4124
Peso (kg/mt)	0,257

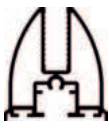

(L) Profilo del Listello

Codice Prodotto	4125
Peso (kg/mt)	0,168



Profili Per Balconi In Vetro			
Immagine.	Profilo N.	Descrizione Del Profilo	Kg / mt
	4118	Profilo della Rotaia	1,425
	4119	Profilo della Rotaia	1,575
	4120	Profilo della Rotaia	1,496
	4121	Pannello Profilo Superiore e Inferiore	0,916
	4122	Pannello Profilo Superiore e Inferiore	0,883
	4123	Dar Yan Kasa Profilo a Montante	0,325
	4124	(H) Profilo del Listello	0,257
	4125	(L) Profilo del Listello	0,168

SERIE PERGOLA

 **BEPRO**

103

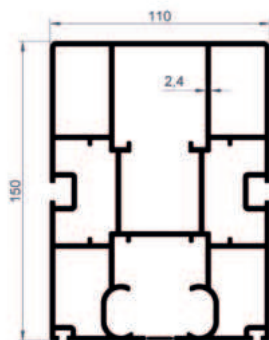

Profilo della Rotaia

Codice Prodotto	4126
Peso (kg/mt)	7,032

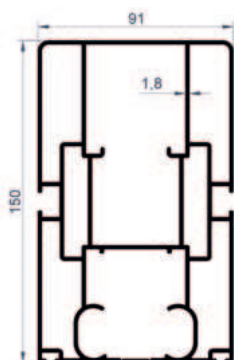

Profilo della Rotaia

Codice Prodotto	4127
Peso (kg/mt)	4,973

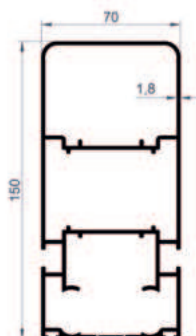

Profilo della Rotaia

Codice Prodotto	4128
Peso (kg/mt)	3,222

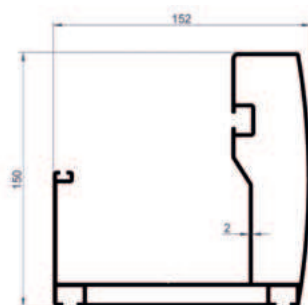

Profilo della Grondaia

Codice Prodotto	4129
Peso (kg/mt)	4,095

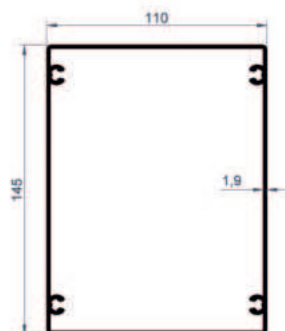

Profilo a Montante

Codice Prodotto	4130
Peso (kg/mt)	2,875

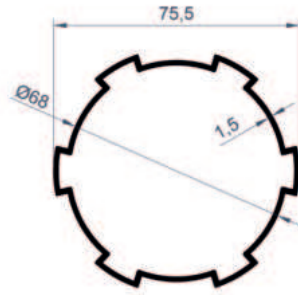
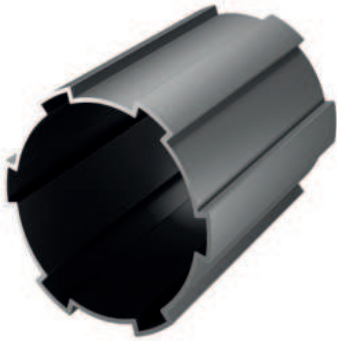

Profilo del Tubo Motore

Codice Prodotto	4131
Peso (kg/mt)	1,100



Profilo Scatola Trapezoidale

Codice Prodotto	4132
Peso (kg/mt)	1,518

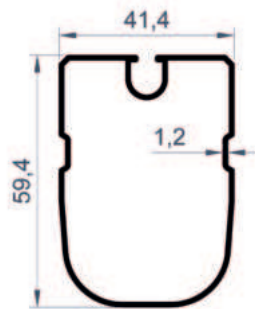

Profilo del Tessuto



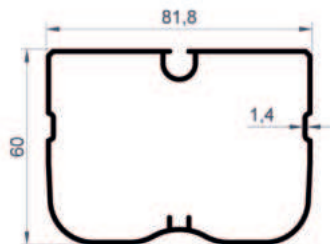



Codice Prodotto	4133
Peso (kg/mt)	0,664

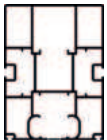
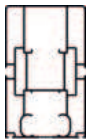

Profilo del Tessuto

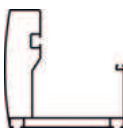
Codice Prodotto	4134
Peso (kg/mt)	1,108

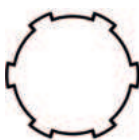

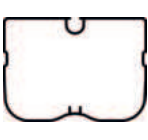
Profili Della Serie Pergola			
Immagine.	Profilo N.	Descrizione Del Profilo	Kg / mt
	4126	Profilo della Rotaia	7,032
	4127	Profilo della Rotaia	4,973
	4128	Profilo della Rotaia	3,222
	4129	Profilo della Grondaia	4,095
	4130	Profilo a Montante	2,875
	4131	Profilo del Tubo Motore	1,100
	4132	Profilo Scatola Trapezoidale	1,518
	4133	Profilo del Tessuto	0,664
	4134	Profilo del Tessuto	1,108

PORTE A FISARMONICA

 **BEPRO**

107





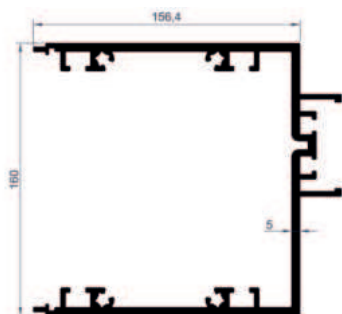

Profilo a Montante

Codice Prodotto	4202
Peso (kg/mt)	8,501

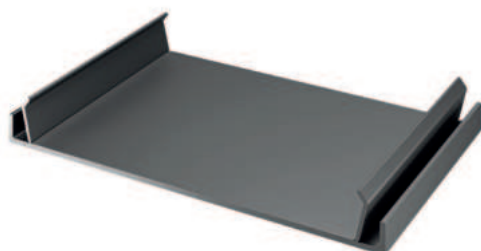

Profilo di Copertura a Puntone

Codice Prodotto	4203
Peso (kg/mt)	1,106

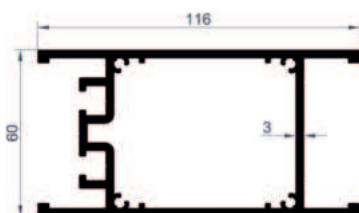
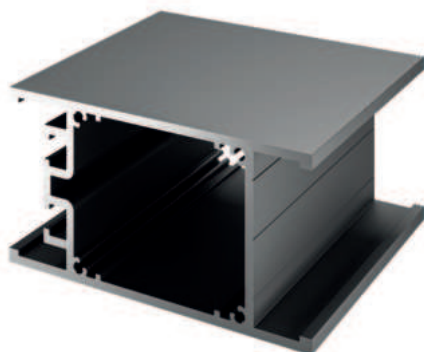

Profilo Dell'Ala del Telaio

Codice Prodotto	4204
Peso (kg/mt)	3,347

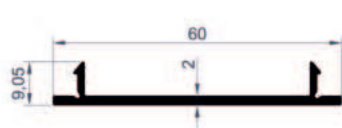
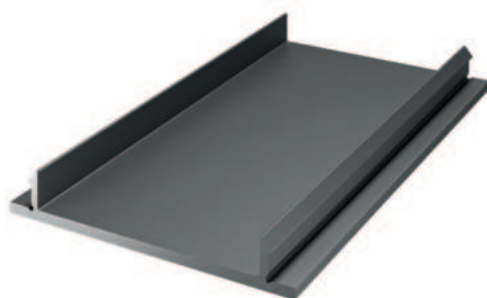

Profilo della Copertura Dell'Ala

Codice Prodotto	4205
Peso (kg/mt)	0,379

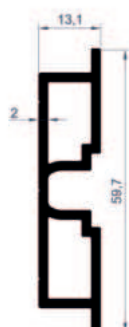

Profilo Dell'Apparato Interno Dell'Ala

Codice Prodotto	4206
Peso (kg/mt)	0,748

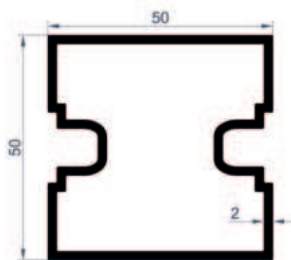

Profilo del Box 50X30

Codice Prodotto	4207
Peso (kg/mt)	1,252

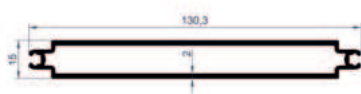
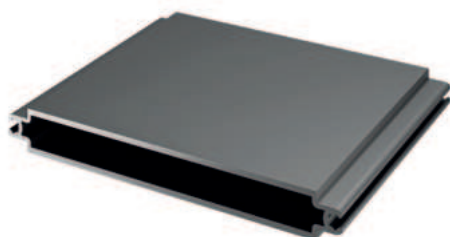

Profilo Lambiri

Codice Prodotto	4208
Peso (kg/mt)	1,466

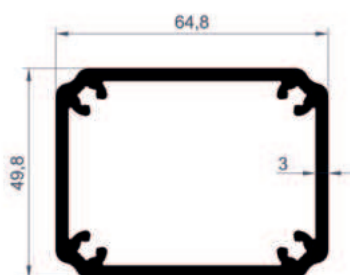
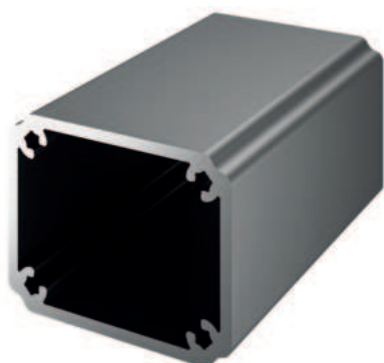

Profilo Ancoraggio Interno Cassa

Codice Prodotto	4209
Peso (kg/mt)	1,984

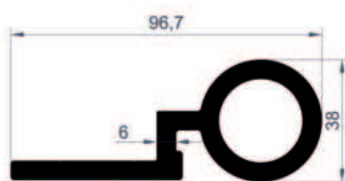

Profilo Cerniera



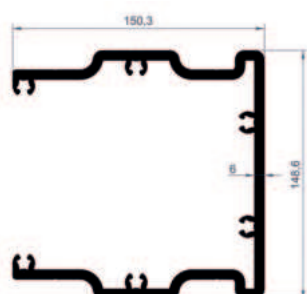





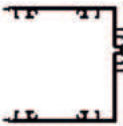

Codice Prodotto	4210
Peso (kg/mt)	2,889



Profilo di Ancoraggio Interno del Montante

Codice Prodotto	4211
Peso (kg/mt)	8,642



Profili Per Porte A Fisarmonica			
Immagine.	Profilo N.	Descrizione Del Profilo	Kg / mt
	4202	Profilo a Montante	8,501
	4203	Profilo di Copertura a Puntone	1,106
	4204	Profilo Dell'Ala del Telaio	3,347
	4205	Profilo della Copertura Dell'Ala	0,379
	4206	Profilo Dell'Apparato Interno Dell'Ala	0,748
	4207	Profilo del Box 50X30	1,252
	4208	Profilo Lambiri	1,466
	4209	Profilo Ancoraggio Interno Cassa	1,984
	4210	Profilo Cerniera	2,889
	4211	Profilo di Ancoraggio Interno del Montante	8,642



Certification is conditional on maintaining the required performance standards throughout the certified period of registration
Amtivo Group Limited, 30 Tower View, Kings Hill, Kent, ME19 4UY

The management system of Certificate Number **626352**
GNS PROFIL ALUMINYUM A.S.
ATAKOY 7-8-9-10 KISIM MAH., NILIFER SOK. NO:4 DB A5 B BLOK D:98, BAKIRKOY/ISTANBUL
has been assessed and certified as meeting the requirements of

ISO 9001:2015

ALUMINUM PROFILE PRODUCTION (SURFACE TREATMENT, ALUMINUM EXTRUSION MOULD DESIGN AND PRODUCTION) FOR VARIOUS SECTORS BOTH DOMESTIC AND WORLDWIDE

Further clarifications regarding the scope of this certificate and the applicability of requirements may be obtained by consulting the certifier.

Valid from
Initial Certification: 11 January 2024
Latest Issue: 11 January 2024
Expiry Date: 10 January 2025
Recertification Before: 10 January 2027
subject to annual assessments

Authorised by

Mike Tims
Chief Executive Officer

Expiry Date: **10 January 2025**

Certificate Number **626352**

Locations Covered



8289

- GNS PROFIL ALUMINYUM A.S.
ATAKOY 7-8-9-10 KISIM MAH., NILIFER SOK. NO:4 DB A5 B BLOK D:98, BAKIRKOY/ISTANBUL
- GNS PROFIL ALUMINYUM A.S.
KARAAGAC OSB MAH., KAPAKLI OSB 104.CAD. NO:15/1, KAPAKLI/ TEKIRDAG, TURKIYE

www.amtivo.com

Certificate issued by Amtivo Group Limited



The validity and status of this certificate can be verified by using the UKAS CertCheck website at certcheck.ukas.com

CERTIFICATE

of Conformity of the Factory Production Control

1922 - CPR - 2181

In compliance with Regulation (EU) No 305/2011 of the European Parliament and of the council of 9 March 2011 (the Construction Products Regulation or CPR), this certificate applies to the construction product

ALUMINIUM AND ALUMINIUM ALLOYS. STRUCTURAL PRODUCTS FOR CONSTRUCTION WORKS. HOT EXTRUDED PROFILES

for load-bearing structural construction works

Alloys: EN AW-6060, EN AW-6063

placed on the market under the name or trade mark of

GNS PROFİL ALÜMİNYUM ANONİM ŞİRKETİ

ATAKÖY 7-8-9-10. KISIM MAH. NİLÜFER SK. A5 BLOK NO: 4 DB İÇ KAPI NO: 98

BAKIRKÖY/ ISTANBUL/TÜRKİYE

and produced in the manufacturing plant

GNS PROFİL ALÜMİNYUM ANONİM ŞİRKETİ

**KARAAĞAÇ OSB MAH. KAPAKLI OSB 104. CAD.NO:15/1 KAPAKLI/TEKİRDAĞ/
TÜRKİYE**

This certificate attests that all provisions concerning the assessment and verification of constancy of performance described in Annex ZA of the standard

EN 15088:2005

under system 2+ are applied and that the factory production control is assessed to be in conformity with the applicable requirements.

This certificate was first issued on 24.04.2024 and will remain valid until 24.04.2025 as long as neither the harmonised standard, the construction product, the AVCP methods nor the manufacturing conditions in the plant are modified significantly, unless suspended or withdrawn by the notified factory production control certification body. The certificate is supported through annual surveillance audit and is reissued after each surveillance audit. The validity of the certificate may be confirmed in the CE register at the web address www.dedal-bg.net.



Manager:

Anna Vasileva



dipl. eng. Anna Vasileva

Issued:
Burgas, 24 April 2024

Ref. No. 01-00

SERTİFİKA

GNS PROFİL ALUMİNYUM A.Ş.

ATAKÖY 7-8-9-10 KISIM MAH. NİLİFER SOK. NO:4 DB A5 B BLOK D:98 BAKIRKÖY/İSTANBUL
KARAAĞAÇ OSB MAH. KAPAKLI OSB 104.CAD. NO:15/1 KAPAKLI/ TEKİRDAĞ

SRS BELGELENDİRME yukarıda adı geçen kuruluşun Müşteri Memnuniyeti ve Şikayet Yönetim Sisteminin aşağıdaki kapsamda denetlendiğini ve standardın gereklerine uygun olduğunu belgelemektedir.

ISO 10002 : 2018

Yurt İçi Ve Yurt Dışı Çeşitli Sektörler İçin Alüminyum Profil Üretimi (Yüzey İşlem, Alüminyum Ekstrüzyon Kalıp Tasarım Ve Üretimi)

Sertifika Başlangıç Tarihi : 15 Ocak 2024
Sertifika Düzenleme Tarihi : 15 Ocak 2024
Sertifika Geçerlilik Tarihi : 14 Ocak 2025
Belgelendirme Periyodu : 3 Yıl
Sertifika No : SRS/EN/10002/15012024-1

Yetkili Onayı:

BÜLENT YILMAZ

Bu belge, adı geçen kuruluşun yönetim sistemlerini yukarıda belirtilen ve her yıl SRS BELGELENDİRME tarafından denetlenecek standart ve yönergelere uygun olarak sürdürdüğü sürece geçerliliğini korur. Bu belgenin mülkiyet hakkı SRS BELGELENDİRME'ye aittir ve makul talep üzerine SRS BELGELENDİRME'ye iade edilmelidir.

SRS ULUSLARARASI BELGELENDİRME TEKNİK KONTROL GÖZETİM ve EĞİTİM HİZMETLERİ LTD. ŞTİ.
Barış Mah. Akdeniz Cad. No:8/1 İç Kapı No:58 Beylikdüzü / İSTANBUL
Tel: +90 212 854 15 10 | www.srscert.com | info@srscert.com



BEPRO

www.bepro.com.tr